

CABLE·RAIL®

Feeney is the ORIGINAL manufacturer of CableRail railing infill and Quick-Connect® automatic-locking cable fittings in the United States. Here's what makes our cable products better than the rest:

- 316 marine-grade stainless steel provides proven protection from the elements including coastal and other harsh environment, ensuring long product lifecycles.
- Premium raw materials validated prior to production, using state-of-the-art technology (X-Ray Fluorescence Spectrometer) to confirm elemental composition.
- High ductility and a lower carbon content makes it stronger and protects against cracking and shattering.
- Product performance and compliance demonstrated through accredited independent testing labs.

CableRail Runs and Spacing

Whether you choose Kits, Fittings + Bulk Cable, or Special Order you will need to calculate how many cable runs you'll need. Here are a couple points to consider:

Horizontal cables need to be spaced no more than 3" to adhere to residential and commercial building codes. Measure from the underside of the top rail down to the bottom rail (or deck surface if not using one) and divide this by 3 to get a rough number of cables.

Cables can run around corners or terminate at double or single corner posts. We recommend no more than 2 corner bends in any run of cable and a maximum length of 50'. For straight runs of cable with no bends, the maximum is 70'. If you have longer runs, you'll need to terminate the cables at an intermediate post, and you'll need to add more kits or assemblies.

Your expert Feeney Estimator can help determine the number of cables needed for each project. Here is a general rule of thumb:

NUMBER OF CABLE RUNS NEEDED					
RAILING HEIGHT	BOTTOM RAIL?	NO. OF RUNS	RAILING HEIGHT	BOTTOM RAIL?	NO. OF RUNS
36"	YES	9	42"	YES	11
36"	NO	11	42"	NO	13

MAX RUN: 50-feet, up to two corner bends

Cable Diameters and Applications



1/8-IN

1/8-IN CABLE

- Perfect for all residential and light commercial projects
- Can be installed on wood or metal frames



3/16-IN

3/16-IN CABLE

- Extra durable option for commercial and residential settings
- Can be installed on wood or metal railing frames



1/4-IN

1/4-IN CABLE

- Largest, most durable option for high-traffic, high-wear commercial locations
- Also for railing designs where the “look” of a larger cable is desired
- Recommended for metal railing frames only

CableRail Frame Construction *(for any CableRail solution)*

Cables must be tensioned properly to ensure railing code compliance, which means that cable railing frames must be constructed to adequately support the cable tension load. Careful attention must be given to the design and materials used for the railing, including post sizes and spacing, as well as the railing attachment.

Minimum Sizes for All Corner and End Posts

(all other posts should be sized as required for top rail support strength or for code)



4X4 WOOD

3-1/2" wide & thick**



FLAT BAR

2" wide,
1" thick



ANGLE IRON

2" wide,
1/2" thick



EXTRA STRONG PIPE

1-1/2" I.D.
1-7/8" O.D.



SQUARE TUBE

2" wide
1/4" wall

**Note: softer woods may require larger post sizes, especially with 42-in high railings

For more information on frame construction and materials, corner options, and other technical considerations, please visit our website: feenevinc.com/Technical-Information.

CABLE·RAIL®

Product Care and Maintenance

Immediately following installation, the product should be cleaned, followed by a regular maintenance schedule. The general recommendation is to perform periodic cleaning once or twice per year. However, **maintenance will be required more frequently, in harsh environments**, including but not limited to those with **exposure to salt chlorides and/or other airborne contaminants, such as ocean salt spray, de-icing salts, swimming pool chemicals, or industrial pollutants**. For areas within 1 mile of salt or brackish water, cleaning must be performed quarterly. Failure to clean product in accordance with these requirements will void this warranty.

Feeney products are designed to work together as a complete system. Utilizing components in other systems could void the warranty.

Feeney, Inc. has established installation parameters in an effort to provide code compliant guard systems. These parameters are based on engineering calculations in accordance with typical building code requirements in most jurisdictions. Any variance or deviation from Feeney's recommended installation parameters cannot be guaranteed to meet building code and this action will void any applicable warranty. Consult with the local AHJ (Authority Having Jurisdiction) to ensure building code compliance for the specific project location.

Feeney offers comprehensive care and maintenance documents categorized by material: one for stainless steel fittings and cables, and one for powder-coated aluminum products. Maintenance instructions can be found on our website along with the warranty documents at feeneyinc.com/warranty-and-care.

Registering your product will ensure ease of contact and resolution in the event of any warranty issues. This information is for internal use only and will not be sold or distributed to any other parties or companies.

Register your product today at feeneyinc.com/product_registration.

Stainless Steel Cleaner Kit

Clean and maintain all stainless steel surfaces, fittings, and cables. Kit includes: (1) bottle of SteelRenewal™, (1) bottle of SteelProtect™, applicator brush and sponge, protective gloves.

See page 44 for ordering information.



CableRail Solutions

GOT CABLERAIL QUESTIONS?

Reach out to your Regional Sales Manager for Product Knowledge training to help you feel confident in selling CableRail.

1 CABLERAIL KITS (page 12)

- Outside to Outside post installation **only**
- Retail Quick Ship Options
- Short, Long, XLong, and Conceal Terminals for different size posts
- Sold in pre-cut standardized lengths
- Each CableRail kit comes with a terminal fitting pre-attached to one end of the cable and a Quick-Connect® fitting for the other end that is field installed.



CABLERAIL KIT (S, L, XL)

Standard Fitting
with End Cap



CABLERAIL CONCEAL KIT

Conceal Fitting with
Low-Profile Cap

2 CABLERAIL FITTINGS + BULK CABLE (page 20)

- Inside to Inside and Outside to Outside post installation options
- Retail Quick Ship Options
- A variety of Quick-Connect® fitting styles are available, easy to install
- Sold as individual fittings and bulk cable, assembled in the field



QUICK-CONNECT®
FITTINGS + BULK CABLE

Inside to Inside Fittings
with no End Caps



QUICK-CONNECT®
FITTINGS + BULK CABLE

Outside to Outside Fittings
with End Caps

3 CABLERAIL CUSTOM SOLUTIONS (page 28)

- For projects with special installation conditions or design aesthetics that go beyond CableRail Kits or Quick-Connect® Fittings + Bulk Cable
- Available in a wide assortment of styles
- May require special tools or precise field measurements for fabrication
- Sold as assemblies that are ready to install, or as individual components that can be assembled in the field

CABLE·RAIL® KITS

CableRail Kits are the easiest cable railing solution: each kit includes everything you need for one run of cable. We offer a variety of kits to suit your project type for both wood and metal frames.

CableRail Kits that are packaged for retail can be ordered from a Feeney Sales Coordinator. Contact your Feeney Estimator for assistance with special order items.

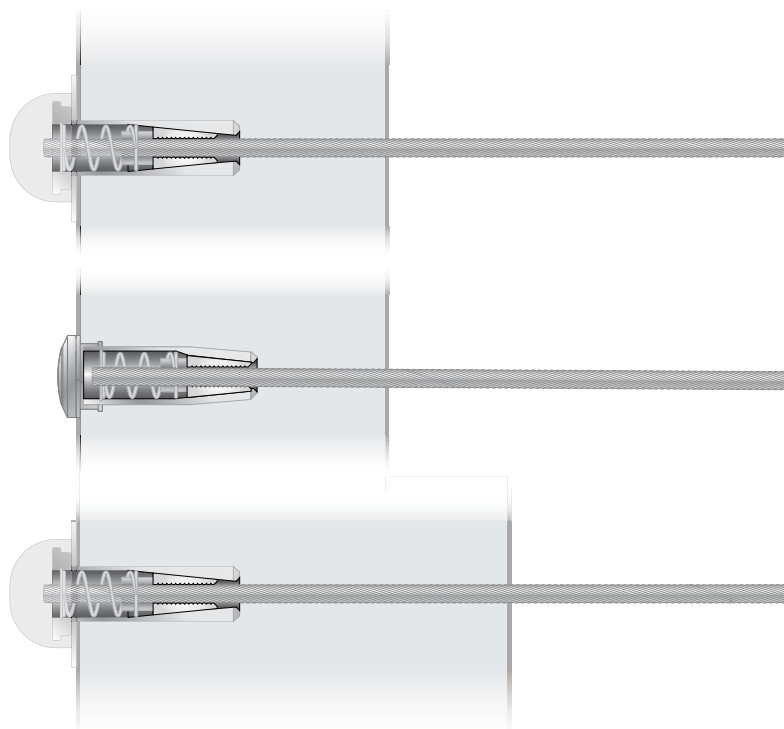

SHORT TERMINAL APPLICATIONS

DesignRail® Post
2 3/8"-IN WIDE

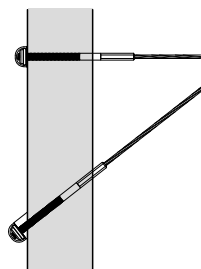

LEVEL/STAIR

4x4 Wood Post
3 1/2"-IN WIDE

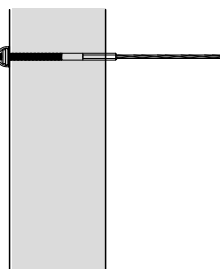

LEVEL ONLY

CABLE DIAMETERS

For residential and light commercial projects, choose 1/8" CableRail Kits.

For heavy duty commercial, choose 3/16" CableRail Kits.



1/8-IN



3/16-IN

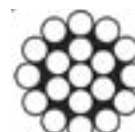

1/4-IN

1/4" CableRail Kits are not recommended for wood frames.

LONG TERMINAL APPLICATIONS

DesignRail® Post
2 3/8"-IN WIDE

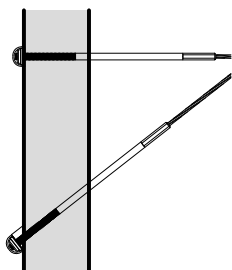

LEVEL/STAIR

4x4 Wood Post
3 1/2"-IN WIDE

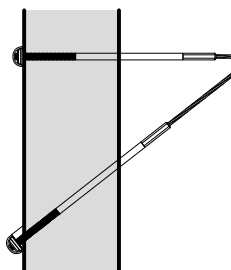

LEVEL/STAIR

6x6 Wood Post*
5 1/2"-IN WIDE

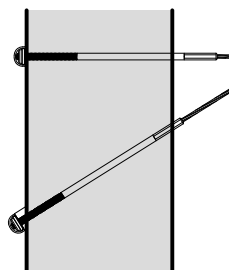

LEVEL/
*STAIR UP TO 32°

CABLE DIAMETERS

For residential and light commercial projects, choose 1/8" CableRail Kits.

For heavy duty commercial, choose 3/16" CableRail Kits.



1/8-IN



3/16-IN

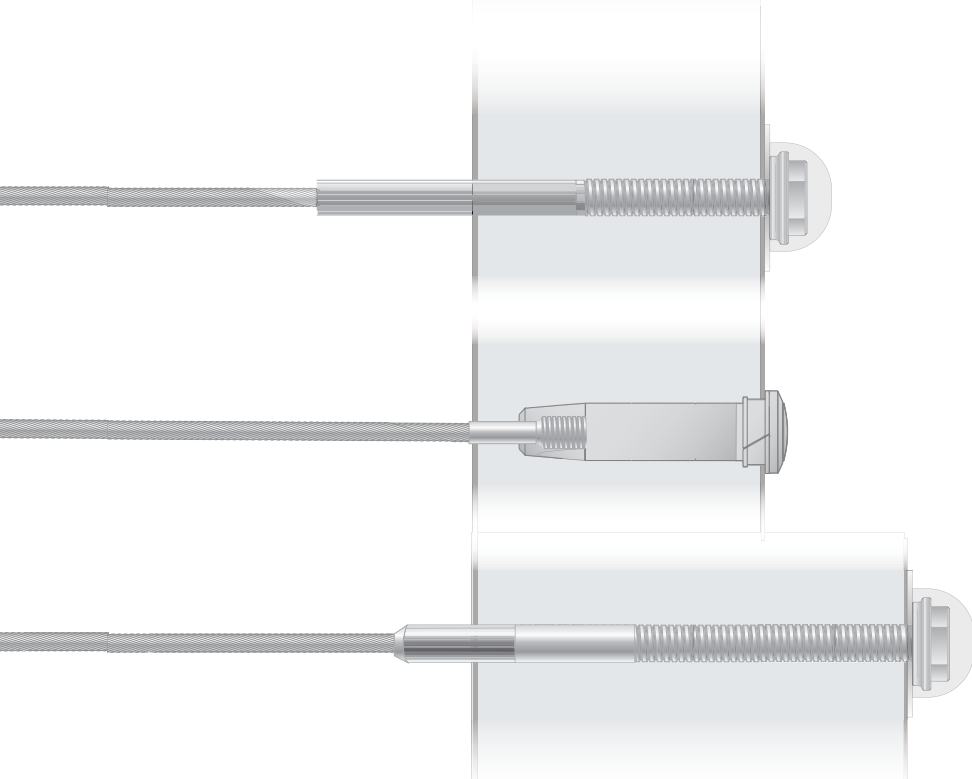

CABLERAIL STANDARD KITS
(LONG/SHORT TERMINAL)

CONCEAL KITS
(CONCEAL TERMINAL)

ALL-THREAD RECEIVER KITS
(XLONG TERMINAL)

NOTE: Special order lengths and cable diameters are available in bulk packaging only.

CONCEAL KIT APPLICATIONS

DesignRail® Custom Post
2 3/8-IN WIDE

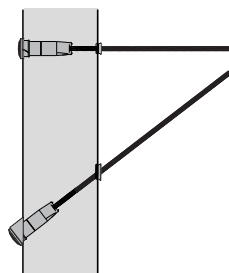

LEVEL/STAIR

4x4 Wood Post
3 1/2-IN WIDE

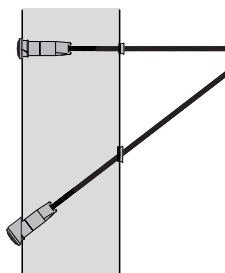

LEVEL/STAIR

CABLE DIAMETERS

For residential and light commercial projects, choose 1/8" Conceal Kits.

Conceal Kits are not available in other cable diameters.



1/8-IN

XLONG (ATR) KIT APPLICATIONS

Oversized Wood Post (columns, piers, pilings)
UP TO 3-FT WIDE

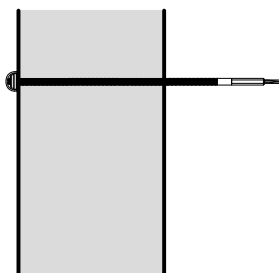

LEVEL

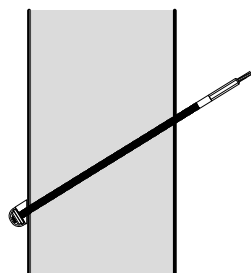

STAIR

CABLE DIAMETERS

For residential and light commercial projects, choose 1/8" CableRail Kits.

For heavy duty commercial, choose 3/16" CableRail Kits.



1/8-IN



3/16-IN

CABLE·RAIL[®] KITS

SHORT TERMINAL (Metal)

CableRail Short Terminal Kits come with everything you need for 1 run of cable, including fittings that attach through the end posts. The 1/8" cable comes in pre-set lengths of 5' to 70' to be trimmed in the field. For level or stair applications. Typically used with DesignRail[®] (Classic Kits, Modern Kits and Custom). *Special Order lengths and cable diameters available in bulk packaging only.*

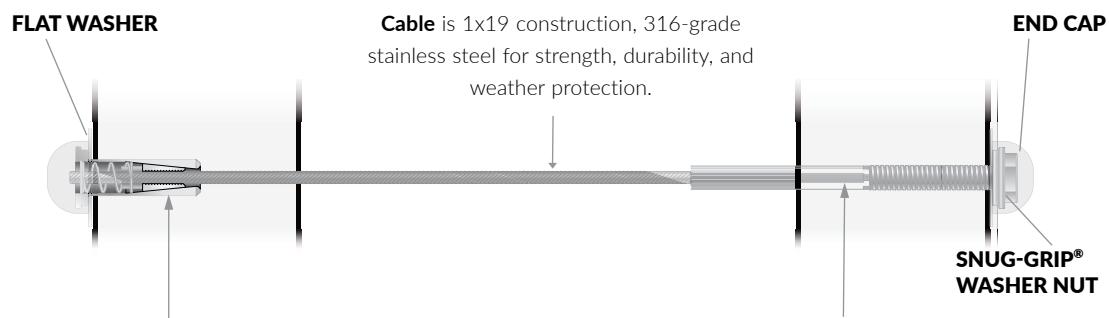

Our unique **Quick-Connect[®] Inset fitting** is attached to the cable in the field without special tools. One-way jaws allow the cable to easily slide through the fitting in one direction and automatically grab and lock-on when the cable is released. Just slip it on, pull the cable tight, and cut the excess.

The **Threaded Terminal fitting** is fastened (swaged) to one end of the cable at the factory. It is then attached to an end post using our unique Snug-Grip[®] Washer Nut with special gripping threads to help prevent the nut from loosening.

Short Terminal Kit Options



Short Terminal Kit includes:

- (1) Quick-Connect[®] Inset Fitting
- (3) Pairs of flat washers*
- (1) Snug-Grip[®] Washer Nut
- (1) Stainless steel cable with 4-1/4" Threaded Terminal

*Stainless steel washers are included for wood posts, and nylon washers for metal posts.

RETAIL ITEM DESCRIPTION	ITEM#	QTY/UNIT	CASE ITEM#	QTY/CASE
1/8" CABLERAIL SHORT TERMINAL KITS				
1/8" X 5 ft CableRail Kit, Short Terminal	CR 1/8 : SS-S-05-PKG (6205-PKG)	1/pack	CR 1/8 : SS-S-05-CS	24 packs
1/8" X 10 ft CableRail Kit, Short Terminal	CR 1/8 : SS-S-10-PKG (6210-PKG)	1/pack	CR 1/8 : SS-S-10-CS	24 packs
1/8" X 15 ft CableRail Kit, Short Terminal	CR 1/8 : SS-S-15-PKG (6215-PKG)	1/pack	CR 1/8 : SS-S-15-CS	24 packs
1/8" X 20 ft CableRail Kit, Short Terminal	CR 1/8 : SS-S-20-PKG (6220-PKG)	1/pack	CR 1/8 : SS-S-20-CS	24 packs
1/8" X 25 ft CableRail Kit, Short Terminal	CR 1/8 : SS-S-25-PKG (6225-PKG)	1/pack	CR 1/8 : SS-S-25-CS	12 packs
1/8" X 30 ft CableRail Kit, Short Terminal	CR 1/8 : SS-S-30-PKG (6230-PKG)	1/pack	CR 1/8 : SS-S-30-CS	12 packs
1/8" X 40 ft CableRail Kit, Short Terminal	CR 1/8 : SS-S-40-PKG (6240-PKG)	1/pack	CR 1/8 : SS-S-40-CS	12 packs
1/8" X 50 ft CableRail Kit, Short Terminal	CR 1/8 : SS-S-50-PKG (6250-PKG)	1/pack	CR 1/8 : SS-S-50-CS	12 packs

These 1/8" CableRail Short Terminal Kits are available via special order:

SPECIAL ORDER ITEM DESCRIPTION	ITEM#
1/8" CABLERAIL KITS - SHORT TERMINAL	
1/8" x 35 ft CableRail Kit (SHORT TERMINAL)	CR 1/8 M : 6235
1/8" x 45 ft CableRail Kit (SHORT TERMINAL)	CR 1/8 M : 6245
1/8" x 55 ft CableRail Kit (SHORT TERMINAL)	CR 1/8 M : 6255
1/8" x 60 ft CableRail Kit (SHORT TERMINAL)	CR 1/8 M : 6260
1/8" x 65 ft CableRail Kit (SHORT TERMINAL)	CR 1/8 M : 6265
1/8" x 70 ft CableRail Kit (SHORT TERMINAL)	CR 1/8 M : 6270



3/16" CableRail Short Terminal Kits are recommended for heavy duty commercial projects.

SPECIAL ORDER ITEM DESCRIPTION	ITEM#
3/16" CABLERAIL KITS - SHORT TERMINAL	
3/16" x 5 ft CableRail Kit (SHORT TERMINAL)	CR 3/16 M : 6705
3/16" x 10 ft CableRail Kit (SHORT TERMINAL)	CR 3/16 M : 6710
3/16" x 15 ft CableRail Kit (SHORT TERMINAL)	CR 3/16 M : 6715
3/16" x 20 ft CableRail Kit (SHORT TERMINAL)	CR 3/16 M : 6720
3/16" x 25 ft CableRail Kit (SHORT TERMINAL)	CR 3/16 M : 6725
3/16" x 30 ft CableRail Kit (SHORT TERMINAL)	CR 3/16 M : 6730
3/16" x 35 ft CableRail Kit (SHORT TERMINAL)	CR 3/16 M : 6735
3/16" x 40 ft CableRail Kit (SHORT TERMINAL)	CR 3/16 M : 6740
3/16" x 45 ft CableRail Kit (SHORT TERMINAL)	CR 3/16 M : 6745
3/16" x 50 ft CableRail Kit (SHORT TERMINAL)	CR 3/16 M : 6750
3/16" x 55 ft CableRail Kit (SHORT TERMINAL)	CR 3/16 M : 6755
3/16" x 60 ft CableRail Kit (SHORT TERMINAL)	CR 3/16 M : 6760
3/16" x 65 ft CableRail Kit (SHORT TERMINAL)	CR 3/16 M : 6765
3/16" x 70 ft CableRail Kit (SHORT TERMINAL)	CR 3/16 M : 6770



Learn more about CableRail Short Terminal Kits on our website

GOT CABLERAIL QUESTIONS?
 Reach out to your Regional Sales Manager for Product Knowledge training to help you feel confident in selling CableRail.



1/4" CableRail Short Terminal Kits are suitable for metal frames ONLY.

SPECIAL ORDER ITEM DESCRIPTION	ITEM#
1/4" CABLERAIL KITS - SHORT TERMINAL	
1/4" x 5 ft CableRail Kit (SHORT TERMINAL)	CR 1/4 M : 6905
1/4" x 10 ft CableRail Kit (SHORT TERMINAL)	CR 1/4 M : 6910
1/4" x 15 ft CableRail Kit (SHORT TERMINAL)	CR 1/4 M : 6915
1/4" x 20 ft CableRail Kit (SHORT TERMINAL)	CR 1/4 M : 6920
1/4" x 25 ft CableRail Kit (SHORT TERMINAL)	CR 1/4 M : 6925
1/4" x 30 ft CableRail Kit (SHORT TERMINAL)	CR 1/4 M : 6930
1/4" x 35 ft CableRail Kit (SHORT TERMINAL)	CR 1/4 M : 6935
1/4" x 40 ft CableRail Kit (SHORT TERMINAL)	CR 1/4 M : 6940
1/4" x 45 ft CableRail Kit (SHORT TERMINAL)	CR 1/4 M : 6945
1/4" x 50 ft CableRail Kit (SHORT TERMINAL)	CR 1/4 M : 6950
1/4" x 55 ft CableRail Kit (SHORT TERMINAL)	CR 1/4 M : 6955
1/4" x 60 ft CableRail Kit (SHORT TERMINAL)	CR 1/4 M : 6960
1/4" x 65 ft CableRail Kit (SHORT TERMINAL)	CR 1/4 M : 6965
1/4" x 70 ft CableRail Kit (SHORT TERMINAL)	CR 1/4 M : 6970

NOTE: SPECIAL ORDER ITEMS are bulk packaged.

CABLE·RAIL® KITS

LONG TERMINAL (Wood)

CableRail Long Terminal Kits come with everything you need for 1 run of cable, including fittings that attach through the end posts. The 1/8" cable comes in pre-set lengths of 5' to 70' to be trimmed in the field. For level or stair applications. *Special Order lengths and cable diameters available in bulk packaging only.*

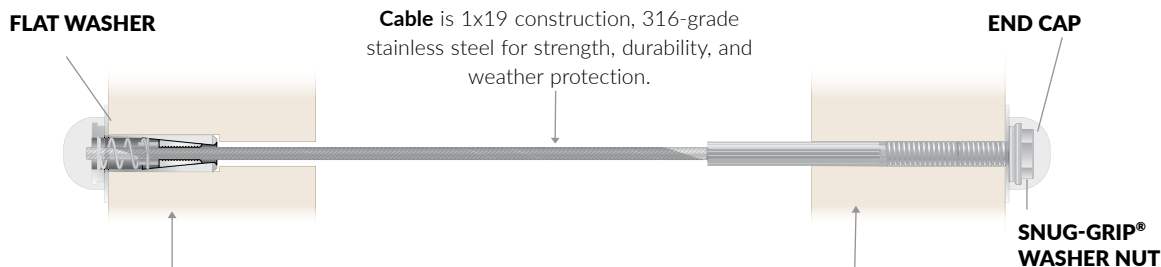

Our unique **Quick-Connect® Inset fitting** is attached to the cable in the field without special tools. One-way jaws allow the cable to easily slide through the fitting in one direction and automatically grab and lock-on when the cable is released. Just slip it on, pull the cable tight, and cut the excess.

The **Threaded Terminal fitting** is fastened (swaged) to one end of the cable at the factory. It is then attached to an end post using our unique Snug-Grip® Washer Nut with special gripping threads to help prevent the nut from loosening.

Long Terminal Kit Options



- Long Terminal Kit includes:**
- (1) Quick-Connect® Inset Fitting*
 - (3) Pairs of flat washers**
 - (1) Snug-Grip® Washer Nut
 - (1) Stainless steel cable with 7-1/2" Threaded Terminal



***Stainless steel washers are included for wood posts, and nylon washers for metal posts.*

RETAIL ITEM DESCRIPTION	ITEM#	QTY/UNIT	CASE ITEM#	QTY/CASE
1/8" CABLERAIL LONG TERMINAL KITS				
1/8" X 5 ft CableRail Kit, Long Terminal	CR 1/8 : SS-L-05-PKG (6305-PKG)	1/pack	CR 1/8 : SS-L-05-CS	24 packs
1/8" X 10 ft CableRail Kit, Long Terminal	CR 1/8 : SS-L-10-PKG (6310-PKG)	1/pack	CR 1/8 : SS-L-10-CS	24 packs
1/8" X 15 ft CableRail Kit, Long Terminal	CR 1/8 : SS-L-15-PKG (6315-PKG)	1/pack	CR 1/8 : SS-L-15-CS	24 packs
1/8" X 20 ft CableRail Kit, Long Terminal	CR 1/8 : SS-L-20-PKG (6320-PKG)	1/pack	CR 1/8 : SS-L-20-CS	24 packs
1/8" X 25 ft CableRail Kit, Long Terminal	CR 1/8 : SS-L-25-PKG (6325-PKG)	1/pack	CR 1/8 : SS-L-25-CS	12 packs
1/8" X 30 ft CableRail Kit, Long Terminal	CR 1/8 : SS-L-30-PKG (6330-PKG)	1/pack	CR 1/8 : SS-L-30-CS	12 packs
1/8" X 40 ft CableRail Kit, Long Terminal	CR 1/8 : SS-L-40-PKG (6340-PKG)	1/pack	CR 1/8 : SS-L-40-CS	12 packs
1/8" X 50 ft CableRail Kit, Long Terminal	CR 1/8 : SS-L-50-PKG (6350-PKG)	1/pack	CR 1/8 : SS-L-50-CS	12 packs
CableRail Stair Kit, Wood 1/8" X 20 ft	6520-PKG	1/pack	6520-CS	24 packs

GOT CABLERAIL QUESTIONS?

Reach out to your Regional Sales Manager for Product Knowledge training to help you feel confident in selling CableRail.

These 1/8" CableRail Long Terminal Kits are available via special order:

SPECIAL ORDER ITEM DESCRIPTION	ITEM#
1/8" CABLERAIL KITS - LONG TERMINAL	
1/8" x 35 ft CableRail Kit (LONG TERMINAL)	CR 1/8 W : 6335
1/8" x 45 ft CableRail Kit (LONG TERMINAL)	CR 1/8 W : 6345
1/8" x 55 ft CableRail Kit (LONG TERMINAL)	CR 1/8 W : 6355
1/8" x 60 ft CableRail Kit (LONG TERMINAL)	CR 1/8 W : 6360
1/8" x 65 ft CableRail Kit (LONG TERMINAL)	CR 1/8 W : 6365
1/8" x 70 ft CableRail Kit (LONG TERMINAL)	CR 1/8 W : 6370

3/16" CableRail Long Terminal Kits are recommended for heavy duty commercial projects.

SPECIAL ORDER ITEM DESCRIPTION	ITEM#
3/16" CABLERAIL KITS - LONG TERMINAL	
3/16" x 5 ft CableRail Kit (LONG TERMINAL)	CR 3/16 W : 6805
3/16" x 10 ft CableRail Kit (LONG TERMINAL)	CR 3/16 W : 6810
3/16" x 15 ft CableRail Kit (LONG TERMINAL)	CR 3/16 W : 6815
3/16" x 20 ft CableRail Kit (LONG TERMINAL)	CR 3/16 W : 6820
3/16" x 25 ft CableRail Kit (LONG TERMINAL)	CR 3/16 W : 6825
3/16" x 30 ft CableRail Kit (LONG TERMINAL)	CR 3/16 W : 6830
3/16" x 35 ft CableRail Kit (LONG TERMINAL)	CR 3/16 W : 6835
3/16" x 40 ft CableRail Kit (LONG TERMINAL)	CR 3/16 W : 6840
3/16" x 45 ft CableRail Kit (LONG TERMINAL)	CR 3/16 W : 6845
3/16" x 50 ft CableRail Kit (LONG TERMINAL)	CR 3/16 W : 6850
3/16" x 55 ft CableRail Kit (LONG TERMINAL)	CR 3/16 W : 6855
3/16" x 60 ft CableRail Kit (LONG TERMINAL)	CR 3/16 W : 6860
3/16" x 65 ft CableRail Kit (LONG TERMINAL)	CR 3/16 W : 6865
3/16" x 70 ft CableRail Kit (LONG TERMINAL)	CR 3/16 W : 6870



Learn more about CableRail
Long Terminal Kits on our website

NOTE: SPECIAL ORDER ITEMS are bulk packaged.

CABLE·RAIL[®] KITS

XLONG TERMINAL (All-Thread Kits)

A flexible solution when dealing with larger end posts like columns, piers, or pilings and where an attachment through the end posts is desired. Each kit comes with everything you need for 1 run of cable. For level or stairs.

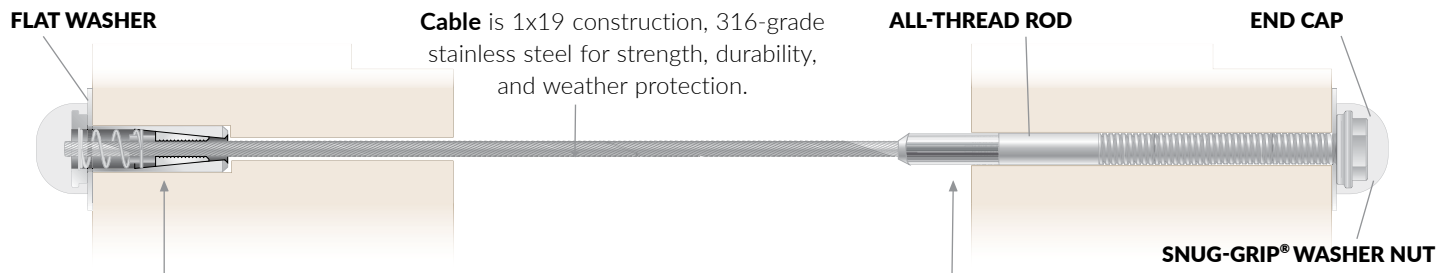

Our unique **Quick-Connect[®] Inset fitting** is attached to the cable in the field without special tools. One-way jaws allow the cable to easily slide through the fitting in one direction and automatically grab and lock-on when the cable is released. Just slip it on, pull the cable tight, and cut the excess.

The **All-Thread Receiver fitting** is fastened (swaged) to one end of the cable at the factory. A length of **All-Thread Rod** is threaded into the Receiver, inserted into an end post, and secured with a Snug-Grip[®] Washer Nut.



Each ATR Kit includes:

- (1) Quick-Connect[®] Inset Fitting
- (1) Pair of stainless steel flat washers
- (1) Snug-Grip[®] Washer Nut
- (1) Stainless steel cable with All-Thread Receiver pre-attached to one end



SPECIAL ORDER ITEM DESCRIPTION	ITEM#
1/8" ALL-THREAD RECEIVER KITS	
1/8" x 5 ft All-Thread Receiver Kit	2005-ATR
1/8" x 10 ft All-Thread Receiver Kit	2010-ATR
1/8" x 15 ft All-Thread Receiver Kit	2015-ATR
1/8" x 20 ft All-Thread Receiver Kit	2020-ATR
1/8" x 25 ft All-Thread Receiver Kit	2025-ATR
1/8" x 30 ft All-Thread Receiver Kit	2030-ATR
1/8" x 35 ft All-Thread Receiver Kit	2035-ATR
1/8" x 40 ft All-Thread Receiver Kit	2040-ATR
1/8" x 45 ft All Thread Receiver Kit	2045-ATR
1/8" x 50 ft All-Thread Receiver Kit	2050-ATR
1/8" x 55 ft All-Thread Receiver Kit	2055-ATR
1/8" x 60 ft All-Thread Receiver Kit	2060-ATR
1/8" x 65 ft All-Thread Receiver Kit	2065-ATR
1/8" x 70 ft All-Thread Receiver Kit	2070-ATR
1/8" ALL-THREAD ROD	
1/8" All-Thread Rod*	4800

SPECIAL ORDER ITEM DESCRIPTION	ITEM#
3/16" ALL-THREAD RECEIVER KITS	
3/16" x 5 ft All-Thread Receiver Kit	4005-ATR
3/16" x 10 ft All-Thread Receiver Kit	4010-ATR
3/16" x 15 ft All-Thread Receiver Kit	4015-ATR
3/16" x 20 ft All-Thread Receiver Kit	4020-ATR
3/16" x 25 ft All-Thread Receiver Kit	4025-ATR
3/16" x 30 ft All-Thread Receiver Kit	4030-ATR
3/16" x 35 ft All-Thread Receiver Kit	4035-ATR
3/16" x 40 ft All-Thread Receiver Kit	4040-ATR
3/16" x 45 ft All-Thread Receiver Kit	4045-ATR
3/16" x 50 ft All-Thread Receiver Kit	4050-ATR
3/16" x 55 ft All-Thread Receiver Kit	4055-ATR
3/16" x 60 ft All-Thread Receiver Kit	4060-ATR
3/16" x 65 ft All-Thread Receiver Kit	4065-ATR
3/16" x 70 ft All-Thread Receiver Kit	4070-ATR
3/16" ALL-THREAD ROD	
3/16" All-Thread Rod*	4801

*Required item - one rod for each ATR kit

CONCEAL TERMINAL (Conceal Kits)

A lower-profile option with slender end caps and special compact cable fittings that hide inside the end posts for a completely symmetrical look. Each kit comes with everything you need for 1 run of cable with fittings that attach through the end posts. These kits can be used with either wood frames or DesignRail® Custom. For level or stair applications.

CONCEAL END CAP

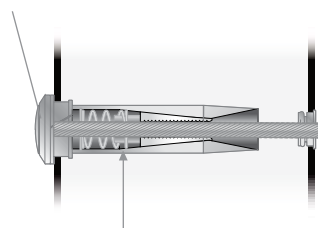

Cable is 1x19 construction, 316-grade stainless steel for strength, durability, and weather protection.

CONCEAL END CAP

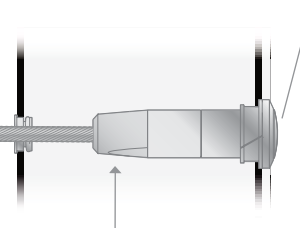

Our unique **Conceal Quick-Connect® fitting** is attached to the cable in the field without special tools. One-way jaws allow the cable to easily slide through the fitting in one direction and automatically grab and lock-on when the cable is released. Just slip it on, pull the cable tight, and cut the excess.

The **Conceal Terminal fitting** is fastened (swaged) to one end of the cable at the factory. It is then attached to an end post with our **Conceal Receiver**.

SPECIAL ORDER ITEM DESCRIPTION	ITEM#
1/8" CABLERAIL CONCEAL KITS	
1/8" x 5 ft CableRail Conceal Kit	CRC 1/8 : 105
1/8" x 10 ft CableRail Conceal Kit	CRC 1/8 : 110
1/8" x 15 ft CableRail Conceal Kit	CRC 1/8 : 115
1/8" x 20 ft CableRail Conceal Kit	CRC 1/8 : 120
1/8" x 25 ft CableRail Conceal Kit	CRC 1/8 : 125
1/8" x 30 ft CableRail Conceal Kit	CRC 1/8 : 130
1/8" x 35 ft CableRail Conceal Kit	CRC 1/8 : 135
1/8" x 40 ft CableRail Conceal Kit	CRC 1/8 : 140
1/8" x 45 ft CableRail Conceal Kit	CRC 1/8 : 145
1/8" x 50 ft CableRail Conceal Kit	CRC 1/8 : 150
1/8" x 55 ft CableRail Conceal Kit	CRC 1/8 : 155
1/8" x 60 ft CableRail Conceal Kit	CRC 1/8 : 160
1/8" x 65 ft CableRail Conceal Kit	CRC 1/8 : 165
1/8" x 70 ft CableRail Conceal Kit	CRC 1/8 : 170



Each Conceal Kit includes:

- (1) Conceal Quick-Connect®
- (1) Conceal Receiver
- (1) Stainless steel cable with a Conceal Terminal pre-attached to one end



Learn more about CableRail
Conceal Kits on our website

NOTE: SPECIAL ORDER ITEMS are bulk packaged.

CABLE·RAIL® FITTINGS

Create your own CableRail assemblies with Feeney Quick-Connect® fittings and bulk cable.

Patented Quick-Connect® Technology

Feeney Quick-Connect® fittings feature patented automatic-locking jaws that grip the cable with no need for specialized tools. These fittings come with a silicone protection seal pre-inserted into the end, providing added protection against dirt and debris entering the body of the fitting. If necessary, our Quick-Connect® Release Tool can be used to disengage and remove or readjust the fitting.



Some Quick-Connect® fittings are available retail packaged and can be ordered from a Feeney Sales Coordinator. Other Quick-Connect® fittings are special order; contact your Feeney Sales Estimator for assistance with those. See fitting detail pages for more details.

Quick-Connect® Fitting Types

Quick-Connect® fittings can be separated into Fixed End fittings and Tension Adjustment fittings. Each run of cable will have two fittings, and at least one of them must be a Tension Adjustment fitting in order to tension the cable line.

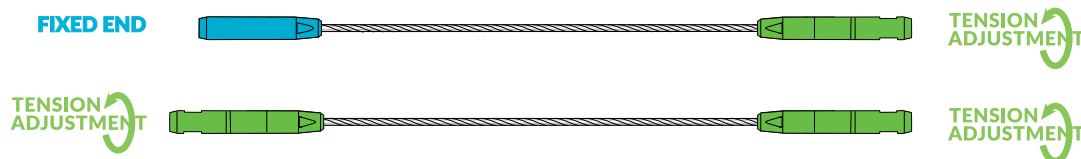

Fixed Ends

These are non-adjustable end termination fittings; they have no tensioning capabilities. Must be paired with a Tension Adjustment fitting.

Tension Adjustment Fittings

These fittings are used to tighten the cable lines by rotating the swivel part of the body. A Tension Adjustment fitting can be paired with either a Fixed End or another Tension Adjustment fitting.

CABLE DIAMETERS

For **residential and light commercial** projects, choose 1/8-in cable. For **heavy duty commercial**, choose 3/16-in cable.



1/8-IN



3/16-IN

Fitting Styles to Suit any Railing

Quick-Connect® fittings are available in a variety of styles for your frame material, application and design aesthetic. Certain fittings attach to the inside post faces (**INSIDE TO INSIDE**) and some pass through the posts (**OUTSIDE TO OUTSIDE**).

LAG FITTINGS (page 22)

Wood and composite frames (**INSIDE TO INSIDE**)

PIVOT FITTINGS (page 23)

Wood and composite frames (**INSIDE TO INSIDE**)

SURFACE MOUNT FITTINGS (page 24)

Wood and composite frames (**INSIDE TO INSIDE**)

JAW FITTINGS (page 25)

Metal frames (**INSIDE TO INSIDE**)

INSET FITTING (page 26)

Wood and metal frames (**OUTSIDE TO OUTSIDE**)

THREADED TERMINAL (page 26)

Wood and metal frames (**OUTSIDE TO OUTSIDE**)

INTERNAL THREAD ADJUSTER (page 26)

Wood and metal frames (**OUTSIDE TO OUTSIDE**)

EXPANSION ANCHORS (page 27)

Anchor into masonry (**INSIDE TO INSIDE**)

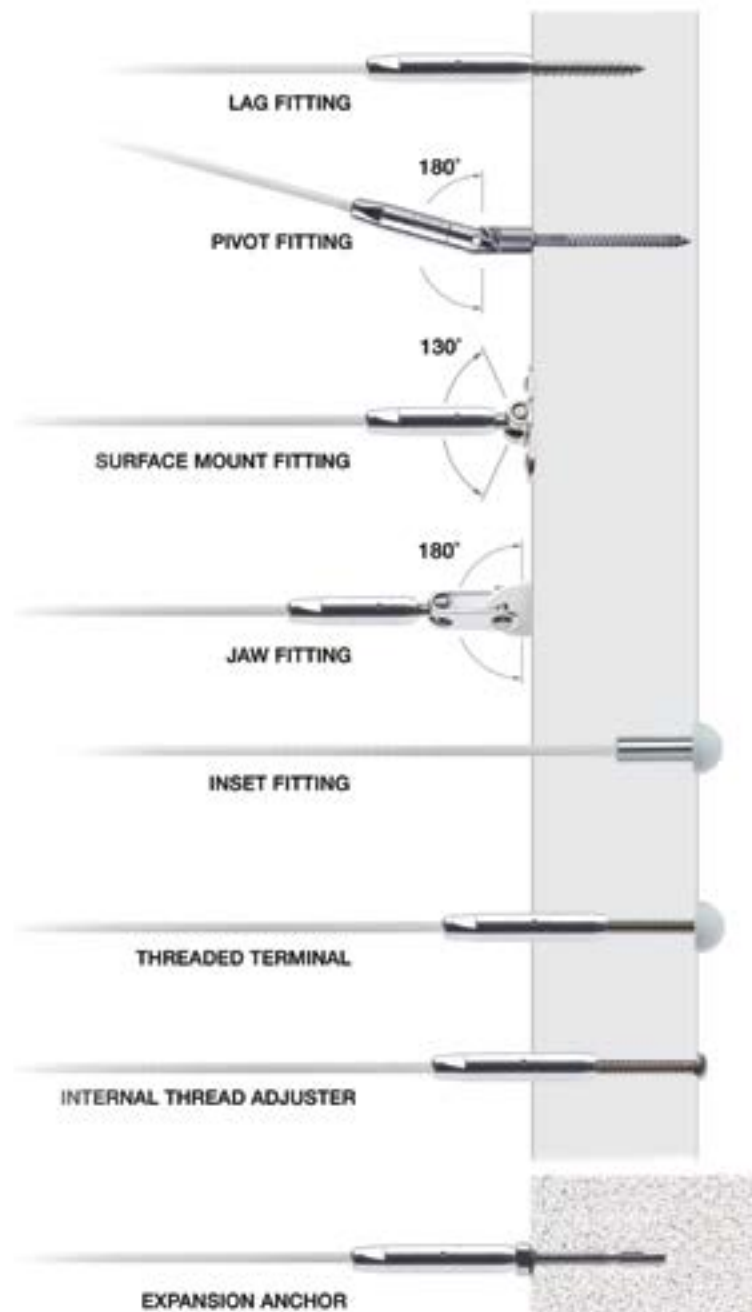

Learn more about CableRail Fittings on our website



CABLE·RAIL® FITTINGS

Quick-Connect® Fittings Make It Easy

For each fitting style, there is generally a Fixed End and a Tension Adjustment fitting that can be paired. Certain fittings attach to the inside post faces (**INSIDE TO INSIDE**) and some pass through the posts (**OUTSIDE TO OUTSIDE**). Frame materials are listed above the chart for each fitting.

Quick-Connect® Lag fittings attach to the inside post face and are best for level railings. Fittings can be installed at an angle for stair applications. Each fitting comes with two hanger bolts: one for wood posts and a longer one for composite sleeved posts.

Quick-Connect® Lag Fixed End (INSIDE TO INSIDE)

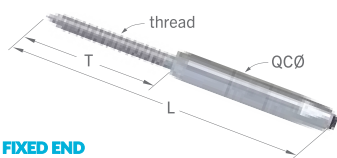

The Quick-Connect® Lag Fixed End must be paired with a Lag Tensioner or another tension adjustment fitting for each run of cable.

FIXED END

WOOD/COMPOSITE FRAME

RETAIL ITEM DESCRIPTION	ITEM# [QTY]	CASE ITEM# [QTY]	CABLEØ	THREAD	T*	L	QCØ	PILOT DRILLØ**
1/8" Quick-Connect® Lag (Fixed End)	9905DL-PKG [1/pack]	9905DL-CS [20 packs]	1/8"	1/4" lag	2" or 2-1/2"	4-1/4"	7/16"	7/64"
SPECIAL ORDER ITEM DESCRIPTION	ITEM#	CABLEØ	THREAD	T*	L	QCØ	PILOT DRILLØ**	
3/16" Quick-Connect® Lag (Fixed End)	9805 [1]	3/16"	5/16" lag	2" or 2-1/2"	5-1/4"	9/16"	7/32"	

*Packaged fitting includes hanger bolts in two lengths.
 **Drill pilot hole slightly larger if using hardwood posts.

Quick-Connect® Lag Tensioner (INSIDE TO INSIDE)

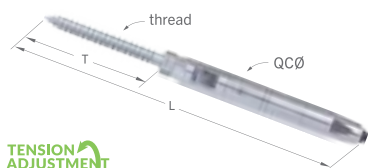

The Quick-Connect® Lag Tensioner is a Tension Adjustment fitting. You may pair a Lag Tensioner with a Lag Fixed End or any other fitting for each run of cable.

WOOD/COMPOSITE FRAME

RETAIL ITEM DESCRIPTION	ITEM# [QTY]	CASE ITEM# [QTY]	CABLEØ	THREAD	T*	L (CLOSED/OPEN)	QCØ	PILOT DRILLØ**
1/8" Quick-Connect® Lag Tensioner	9910DL-PKG [1/pack]	9910DL-CS [20 packs]	1/8"	1/4" lag	2" or 2-1/2"	5-1/4" (5-3/4")	7/16"	7/64"
SPECIAL ORDER ITEM DESCRIPTION	ITEM#	CABLEØ	THREAD	T*	L (CLOSED/OPEN)	QCØ	PILOT DRILLØ**	
3/16" Quick-Connect® Lag Tensioner	9810 [1]	3/16"	5/16" lag	2" or 2-1/2"	5-7/8" (6-7/8")	9/16"	7/32"	

*Packaged fitting includes hanger bolts in two lengths.
 **Drill pilot hole slightly larger if using hardwood posts.

Quick-Connect® Pivot fittings attach to the inside post face and can pivot 180°, making them ideal for stair railings. Pivot fittings can also be installed horizontally for level applications. Each fitting comes with two hanger bolts: one for wood posts and a longer one for composite sleeved posts.

Quick-Connect® Pivot Fixed End (INSIDE TO INSIDE)

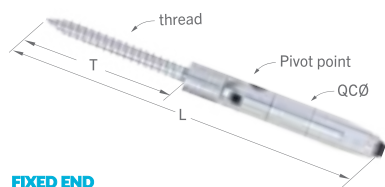

The Quick-Connect® Pivot Fixed End must be paired with a Pivot Tensioner or another tension adjustment fitting for each run of cable.

FIXED END

WOOD/COMPOSITE FRAME

RETAIL ITEM DESCRIPTION	ITEM# [QTY]	CASE ITEM# [QTY]	CABLEØ	THREAD	T*	L	QCØ	PILOT DRILLØ**
1/8" Quick-Connect® Pivot (Fixed End)	9915DL-PKG [1/pack]	9915DL-CS [20 packs]	1/8"	1/4" lag	2" or 2-1/2"	4-3/8"	7/16"	7/64"
SPECIAL ORDER ITEM DESCRIPTION	ITEM#	CABLEØ	THREAD	T*	L	QCØ	PILOT DRILLØ**	
3/16" Quick-Connect® Pivot (Fixed End)	9815 [1]	3/16"	5/16" lag	2" or 2-1/2"	5-1/2"	9/16"	7/32"	

*Packaged fitting includes hanger bolts in two lengths.

**Drill pilot hole slightly larger if using hardwood posts.

Quick-Connect® Pivot Tensioner (INSIDE TO INSIDE)

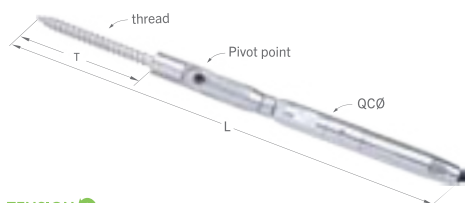

The Quick-Connect® Pivot Tensioner is a Tension Adjustment fitting. You may pair a Pivot Tensioner with a Pivot Fixed End or any other fitting for each run of cable.

TENSION ADJUSTMENT

WOOD/COMPOSITE FRAME

RETAIL ITEM DESCRIPTION	ITEM# [QTY]	CASE ITEM# [QTY]	CABLEØ	THREAD	T*	L (CLOSED/OPEN)	QCØ	PILOT DRILLØ**
1/8" Quick-Connect® Pivot Tensioner	9916DL-PKG [1/pack]	9916DL-CS [20 packs]	1/8"	1/4" lag	2" or 2-1/2"	5-1/4" (5-3/4")	7/16"	7/64"
SPECIAL ORDER ITEM DESCRIPTION	ITEM#	CABLEØ	THREAD	T*	L (CLOSED/OPEN)	QCØ	PILOT DRILLØ**	
3/16" Quick-Connect® Pivot Tensioner	9816 [1]	3/16"	5/16" lag	2" or 2-1/2"	5-7/8" (6-7/8")	9/16"	7/32"	

*Packaged fitting includes hanger bolts in two lengths.

**Drill pilot hole slightly larger if using hardwood posts.

NOTE: SPECIAL ORDER ITEMS are bulk packaged.

CABLE·RAIL® FITTINGS

Quick-Connect® Surface Mount fittings attach to the inside post face and can pivot 130°, making them ideal for stair railings. Each fitting comes with two 1/4" x 2" Square Drive Pan Head Screws for mounting. Can be used with wood or metal railing frames.

Quick-Connect® Surface Mount Fixed End (INSIDE TO INSIDE)

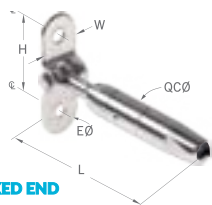

The Quick-Connect® Surface Mount Fixed End must be paired with a Surface Mount Tensioner or another tension adjustment fitting for each run of cable.

FIXED END

WOOD/METAL FRAME

RETAIL ITEM DESCRIPTION	ITEM# [QTY]	CASE ITEM# [QTY]	CABLEØ	EØ	H	W	L	QCØ
1/8" Quick-Connect® Surface Mount (Fixed End)	9903W-PKG [1/pack]	9903W-CS [20 packs]	1/8"	1/4"	1-5/16"	5/8"	2-1/2"	7/16"
SPECIAL ORDER ITEM DESCRIPTION	ITEM#	CABLEØ	EØ	H	W	L	QCØ	
3/16" Quick-Connect® Surface Mount (Fixed End)	9803 [1]	3/16"	5/16"	1-1/2"	3/4"	3-1/4"	9/16"	

Quick-Connect® Surface Mount Tensioner (INSIDE TO INSIDE)

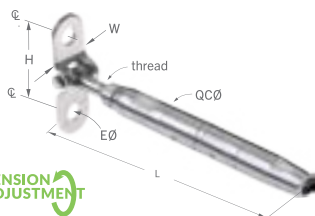

The Quick-Connect® is a Tension Adjustment fitting. You may pair one Surface Mount Tensioner with one Surface Mount Fixed End or any other fitting for each run of cable.

TENSION ADJUSTMENT

WOOD/METAL FRAME

RETAIL ITEM DESCRIPTION	ITEM# [QTY]	CASE ITEM# [QTY]	CABLEØ	THREAD	EØ	H	W	L (CLOSED/OPEN)	QCØ
1/8" Quick-Connect® Surface Mount Tensioner	9913W-PKG [1/pack]	9913W-CS [20 packs]	1/8"	1/4-20	1/4"	1-5/16"	5/8"	4" (4-3/4")	7/16"
SPECIAL ORDER ITEM DESCRIPTION	ITEM#	CABLEØ	THREAD	EØ	H	W	L (CLOSED/OPEN)	QCØ	
3/16" Quick-Connect® Surface Mount Tensioner	9813 [1]	3/16"	5/16-18	5/16"	1-1/2"	3/4"	4-1/2" (5-1/2")	9/16"	

Quick-Connect® Surface Mount Turnbuckle (INSIDE TO INSIDE)

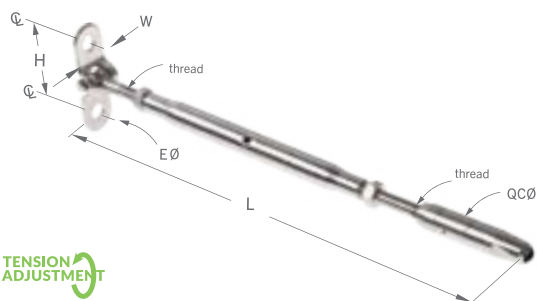

The Quick-Connect® Surface Mount Turnbuckle is a Tension Adjustment fitting. You may pair a Surface Mount Turnbuckle with a Surface Mount Fixed End or any other fitting for each run of cable.

TENSION ADJUSTMENT

WOOD/METAL FRAME

SPECIAL ORDER ITEM DESCRIPTION	ITEM#	CABLEØ	THREAD	EØ	H	W	L (CLOSED/OPEN)	QCØ
1/8" Quick-Connect® Surface Mount Turnbuckle	9902W [1]	1/8"	1/4-28	1/4"	1-5/16"	5/8"	7-3/4" (11")	7/16"

Quick-Connect® Jaw fittings are used for railings with metal posts. The fittings attach to the inside post face and can pivot 180°, making them ideal for stair railings. Jaw fittings can also be installed horizontally for level applications.

Quick-Connect® Jaw Fixed End (INSIDE TO INSIDE)

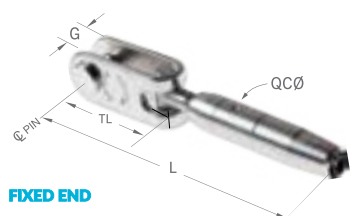

The Quick-Connect® Jaw Fixed End must be paired with a Jaw Tensioner or another tension adjustment fitting for each run of cable.

SPECIAL ORDER ITEM DESCRIPTION	ITEM#	CABLEØ	PinØ	TL	G	L	QCØ	PIN DRILLØ
1/8" Quick-Connect® Jaw (Fixed End)	9901 [1]	1/8"	1/4"	7/8"	5/16"	3-1/4"	7/16"	5/16"
3/16" Quick-Connect® Jaw (Fixed End)	9801 [1]	3/16"	5/16"	1"	3/8"	4-5/8"	9/16"	3/8"

Quick-Connect® Jaw Tensioner (INSIDE TO INSIDE)

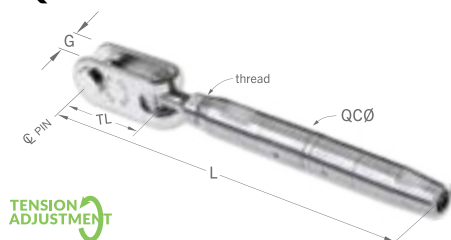

The Quick-Connect® Jaw Tensioner is a Tension Adjustment fitting. You may pair a Jaw Tensioner with a Jaw Fixed End or any other fitting for each run of cable.

SPECIAL ORDER ITEM DESCRIPTION	ITEM#	CABLEØ	THREAD	PINØ	G	L (CLOSED/OPEN)	QCØ	PIN DRILLØ
1/8" Quick-Connect® Jaw Tensioner	9912 [1]	1/8"	1/4-20	1/4"	5/16"	4-3/4" (5-1/2")	7/16"	5/16"
3/16" Quick-Connect® Jaw Tensioner	9812 [1]	3/16"	5/16-18	5/16"	3/8"	5-3/8" (6-3/8")	9/16"	3/8"

Quick-Connect® Jaw Turnbuckle (INSIDE TO INSIDE)

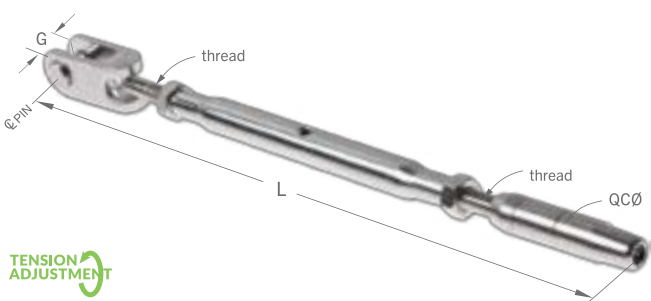

The Quick-Connect® Jaw Turnbuckle is a Tension Adjustment fitting. You may pair a Jaw Turnbuckle with a Jaw Fixed End or any other fitting for each run of cable.

SPECIAL ORDER ITEM DESCRIPTION	ITEM#	CABLEØ	THREAD	PINØ	G	L (CLOSED/OPEN)	QCØ	PIN DRILLØ
1/8" Quick-Connect® Jaw Turnbuckle	9902W [1]	1/8"	1/4-20	1/4"	5/16"	8-1/2" (11-3/4")	7/16"	5/16"

NOTE: SPECIAL ORDER ITEMS are bulk packaged.

CABLE·RAIL® FITTINGS

Quick-Connect® Inset (OUTSIDE TO OUTSIDE)



FIXED END

For wood or metal posts, Inset fittings are inserted into the post with the wider end resting on the outside post face. These fittings can be installed at an angle with beveled washers for stair railings. Pair an Inset fitting with any tension adjustment fitting for one run of cable.

WOOD/METAL FRAME

RETAIL ITEM DESCRIPTION	ITEM# [QTY]	CASE ITEM# [QTY]	BULK#	CABLEØ	CØ	BØ	L	DRILLØ**
1/8" Quick-Connect® Inset (Fixed End)	3146-PKG [1/pack]	3146W-CS [24 packs]	3146	1/8"	5/8"	3/8"	1-1/8"	3/8"

SPECIAL ORDER ITEM DESCRIPTION	ITEM#	CABLEØ	CØ	BØ	L	DRILLØ**
3/16" Quick-Connect® Inset (Fixed End)	3147	3/16"	3/4"	17/32"	1-5/8"	9/16"
1/4" Quick-Connect® Inset (Fixed End)	3148	1/4"	3/4"	17/32"	1-5/8"	9/16"

**May counterbore with slightly larger diameter drill to embed Quick-Connect® body into post

Quick-Connect® Threaded Terminal (OUTSIDE TO OUTSIDE)

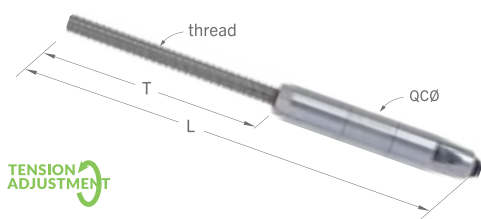

TENSION ADJUSTMENT

For wood or metal posts, Threaded Terminal fittings pass through the post and attach to the outside face with a flat washer and a Snug-Grip® washer nut. These fittings can be installed at an angle with beveled washers for stair railings. Can be paired an Inset fittings or any other fitting for one run of cable.

WOOD/METAL FRAME

RETAIL ITEM DESCRIPTION	ITEM# [QTY]	CASE ITEM# [QTY]	CABLEØ	THREAD	T	L	QCØ	DRILLØ**
1/8" Quick-Connect® Threaded Terminal	9904-PKG [1/pack]	9904-CS [20 packs]	1/8"	5/8"	3/8"	1-1/8"	7/16"	5/16"

SPECIAL ORDER ITEM DESCRIPTION	ITEM#	CABLEØ	THREAD	T	L	QCØ	DRILLØ**
3/16" Quick-Connect® Threaded Terminal	9804	3/16"	5/16-24	5"	7-3/8"	9/16"	7/16"

Quick-Connect® Internal Thread Adjuster (OUTSIDE TO OUTSIDE)

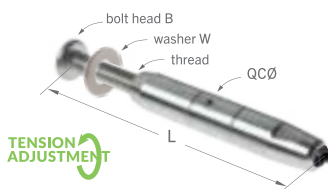

TENSION ADJUSTMENT

For wood or metal posts, Internal Thread Adjusters pass through the post to attach to the outside. These fittings can be installed at an angle with beveled washers for stair railings. Can be paired with an Inset fitting or any other fitting for each run of cable.

WOOD/METAL FRAME

SPECIAL ORDER ITEM DESCRIPTION	ITEM#	CABLEØ	THREAD	BØ	WØ	L (CLOSED/OPEN)	QCØ	DRILLØ**
1/8" Quick-Connect® Internal Thread Adjuster (1-1/2" bolt)	9907-PKG	1/8"	1/4-20	7/16"	11/16"	2-3/4" (3-1/2")	7/16"	5/16"
1/8" Quick-Connect® Internal Thread Adjuster (2" bolt)	9908-PKG	1/8"	1/4-20	7/16"	11/16"	3-1/4" (4")	7/16"	5/16"
1/8" Quick-Connect® Internal Thread Adjuster (3" bolt)	9909-PKG	1/8"	1/4-20	7/16"	11/16"	4-1/4" (5")	7/16"	5/16"
3/16" Quick-Connect® Internal Thread Adjuster (1-1/2" bolt)	9807	3/16"	5/16-18	1/2"	3/4"	3-1/4" (4")	9/16"	3/8"

Quick-Connect® Expansion Anchor fittings are used for attaching cables to masonry and are best for level railings.

Quick-Connect® Expansion Anchor Fixed End (INSIDE TO INSIDE)

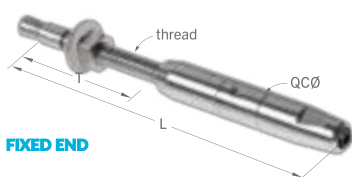

The Quick-Connect® Expansion Anchor Fixed End must be paired with an Expansion Anchor Tensioner or another tension adjustment fitting for each run of cable.

MASONRY

SPECIAL ORDER ITEM DESCRIPTION	ITEM#	CABLEØ	THREAD	T	L (CLOSED/OPEN)	QCØ	DRILLØ**
3/16" Quick-Connect® Expansion Anchor (Fixed End)	9906-PKG	1/8"	5/16-24	1-1/2"	4-1/4" (5")	7/16"	1/4"

Quick-Connect® Expansion Anchor Tensioner (INSIDE TO INSIDE)

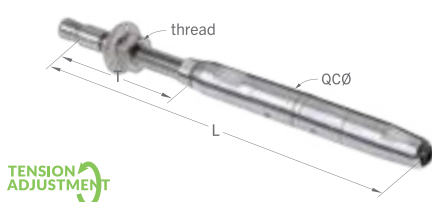

The Quick-Connect® Expansion Anchor Tensioner is a Tension Adjustment fitting. You may pair an Expansion Anchor Tensioner with an Expansion Anchor Fixed End or any other fitting.

MASONRY

SPECIAL ORDER ITEM DESCRIPTION	ITEM#	CABLEØ	THREAD	T	L (CLOSED/OPEN)	QCØ	DRILLØ**
3/16" Quick-Connect® Expansion Anchor Tensioner	9914-PKG	1/8"	1/4-20	1-1/2"	4-1/4" (5")	7/16"	1/4"

Bulk Cable (REQUIRED)

Our cable is made from Type-316 stainless steel in a 1x19 construction, available in three diameters. Bulk cable is required for Quick-Connect® fittings; choose the diameter that matches your fittings.

RETAIL ITEM DESCRIPTION	ITEM# [QTY]
1/8" x 100' reel of 1x19 SSAC T316	5100 [100'/box]
1/8" x 250' reel of 1x19 SSAC T316	5250 [250'/reel]
1/8" x 500' reel of 1x19 SSAC T316	5500 [500'/reel]

SPECIAL ORDER ITEM DESCRIPTION	ITEM# [QTY]
1/8" diameter 1x19 SSAC T316 (sold by the foot)	4140 [/ft] (2500'/full reel)
3/16" diameter 1x19 SSAC T316 (sold by the foot)	4117 [/ft] (1000'/full reel)



Protection Seals

Each Quick-Connect® Fitting comes with a Protection Seal to protect it from debris. Replacement seals are available:

RETAIL ITEM DESCRIPTION	ITEM# [QTY]	CASE ITEM# [QTY]	BULK#
Protection Seals - 1/8"	9917-PKG [20/pack]	9917-CS [10 packs]	9917

SPECIAL ORDER ITEM DESCRIPTION	ITEM#
Protection Seals - 3/16"	9918



NOTE: SPECIAL ORDER ITEMS are bulk packaged.

CABLE·RAIL[®] CUSTOM

Projects with special installation conditions or design considerations may require certain styles of cable and fittings not addressed by our CableRail Kits or Quick-Connect fittings. To fulfill those specific design and function needs, Feeney offers a wide assortment of cables, turnbuckles, terminals, adjusters, and fixed ends for custom assemblies.

You can either order individual components and build your own assemblies, or let us fabricate them for you, ready to install. For technical assistance and ordering, contact a Feeney Sales Estimator.

Cable Attachment Types

Cables can be attached to swaged fittings either at our factory or in the field.

Machine Swaging **M**

Machine swage fittings are attached to the cable at our factory using a hydraulic cold forming press. The swage shank portion of the fitting is pressed on to the end of the cable and has a uniform hexagonal shape when finished. Assemblies using Machine Swage type fittings are fabricated to your exact lengths in our factory and then shipped ready to install.

CableCrimp[™] Hand Swaging **C**

CableCrimp[™] style fittings are attached to the cable by hand in the field using a special CableCrimp[™] Crimper tool (page 37). After proper crimping, the fitting will display several evenly spaced compression marks where the tool was engaged. Most 1/8-in and 3/16-in cable fittings are available in CableCrimp[™] styles.

Custom Fitting Types

All of our cables and fittings are manufactured from high-quality 316-grade stainless steel with a tumbled satin finish for weather-tough durability, low maintenance, and lasting beauty. There are two types of cable fittings: **Fixed End** fittings, and **Tension Adjustment** fittings.

Every cable assembly must have at least one Tension Adjustment Fitting in order to tension the line. The illustration below shows some typical fitting configurations:

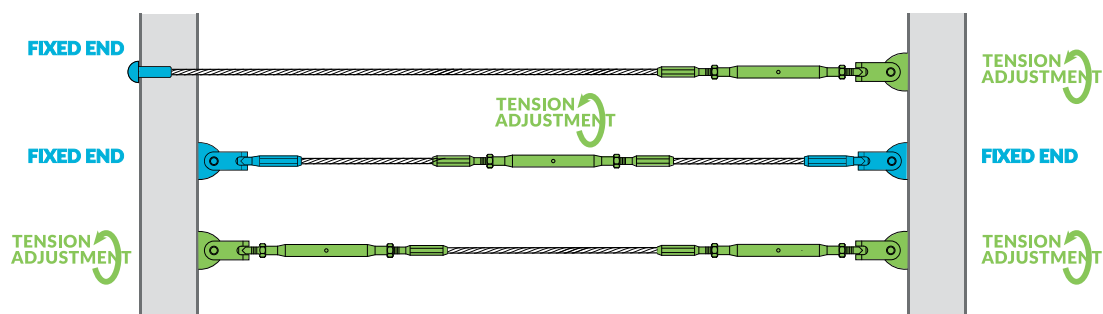

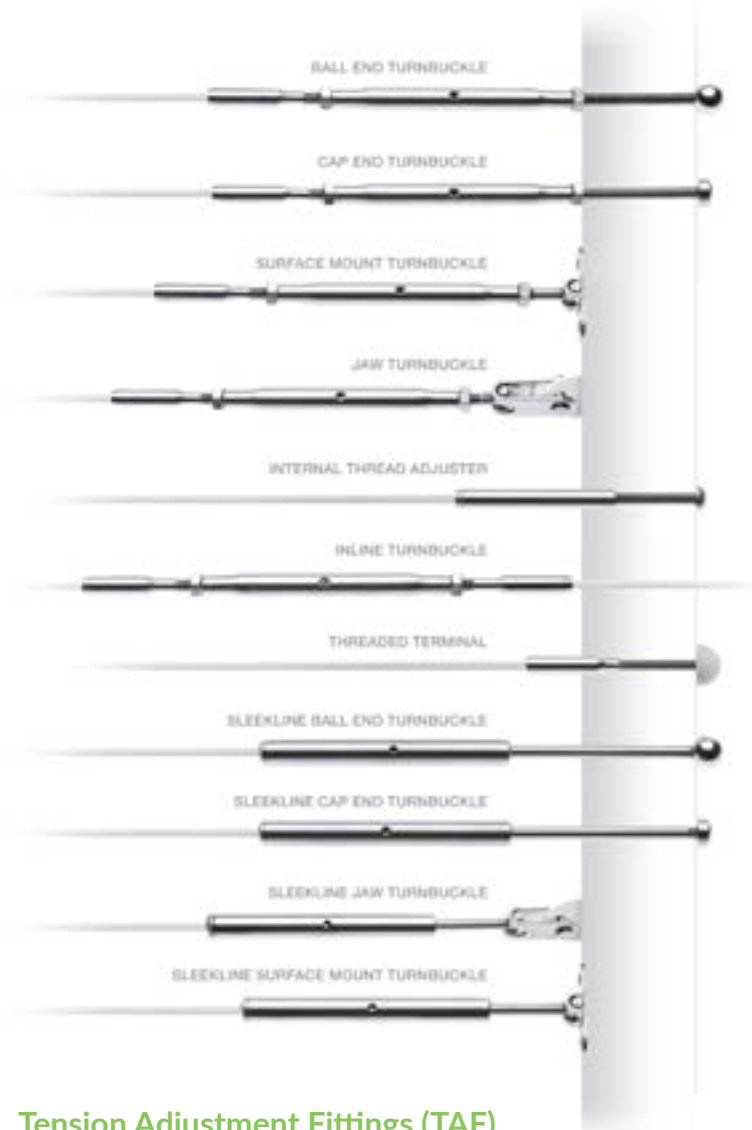
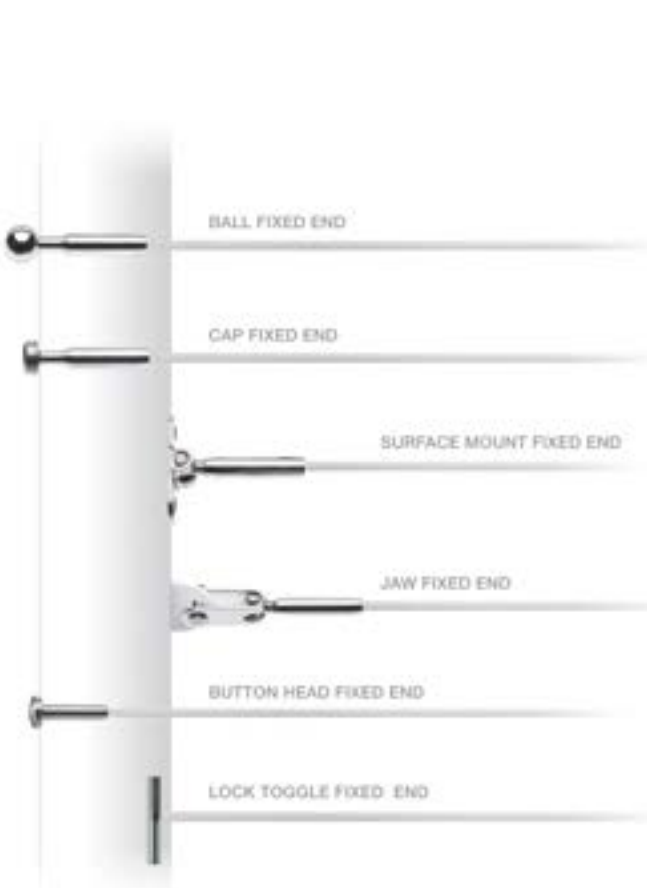

Fixed Ends (FE)

- Non-adjustable end termination fittings, sometimes referred to as “dead ends”
- Have no tensioning capabilities
- Each Fixed End must be paired with at least one Tension Adjustment Fitting

Custom fittings are only available special order.

Tension Adjustment Fittings (TAF)

- Includes Threaded Terminals, Turnbuckles, and Adjusters that are used to tighten the cable assemblies
- Tension is adjusted by tightening the nut on the Threaded Terminals, spinning the tubular body on the Turnbuckles, or rotating the bolt on the Adjusters
- Tension Adjustment fittings can be paired with either a Fixed End or another Tension Adjustment Fitting

IMPORTANT NOTE:

CableRail custom cables, fittings, and assemblies should never be used for lifting, hanging, load-bearing, or other potentially dangerous applications.

Learn more about CableRail Custom Solutions on our website



CABLE·RAIL[®] CUSTOM

Fixed End Fittings

Custom assemblies with a unique look. These fittings are available pre-attached (machine swaged **M**) or ready to attach in the field (CableCrimp™ **C**) using a CableCrimp™ tool. For use with Feeney Bulk Cable only. NOTE: Fixed ends must be paired with a Tension Adjustment fitting to complete the assembly.

Ball Fixed End

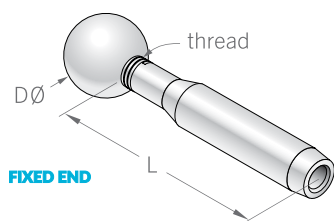

- Inserts through a drill hole or slot in the end post and is secured with a screw-on ball
- Ball pivots to allow angled stair terminations without beveled washers
- Typically paired with a Ball End Turnbuckle

WOOD/METAL FRAME

SWAGE	ITEM DESCRIPTION	ITEM#	CableØ	Thread	DØ	L	DrillØ*
M	1/8" Ball Fixed End	3352	1/8"	1/4-28RH	5/8"	1-1/4"	5/16"
M	3/16" Ball Fixed End	3353	3/16"	1/4-28RH	5/8"	1-3/4"	3/8"
M	1/4" Ball Fixed End	3354	1/4"	5/16-24RH	5/8"	2"	7/16"
C	1/8" Ball Fixed End	3355	1/8"	1/4-28RH	5/8"	1-7/8"	5/16"
C	3/16" Ball Fixed End	3356	3/16"	1/4-28RH	5/8"	2-1/4"	3/8"

*Ball can be slightly recessed into post by counterboring with 9/16" drill.

Cap Fixed End

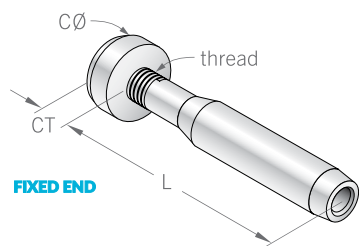

- Inserts through a drill hole in the end post and is secured with a screw-on end cap
- Use beveled washers (#3793) for angled stair terminations and flat washers (page 33) for added bearing surface on wood posts
- Typically paired with a Cap End Turnbuckle

WOOD/METAL FRAME

SWAGE	ITEM DESCRIPTION	ITEM#	CableØ	Thread	CØ	L	DrillØ
M	1/8" Cap Fixed End	3315	1/8"	1/4-28RH	9/16"	1-3/8"	5/16"
M	3/16" Cap Fixed End	3316	3/16"	1/4-28RH	9/16"	1-7/8"	3/8"
M	1/4" Cap Fixed End	3317	1/4"	5/16-24RH	9/16"	2-1/8"	7/16"
C	1/8" Cap Fixed End	3318	1/8"	1/4-28RH	9/16"	2"	5/16"
C	3/16" Cap Fixed End	3319	3/16"	1/4-28RH	9/16"	2-3/8"	3/8"

Surface Mount Fixed End

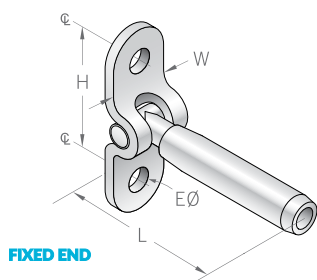

- Attaches to the face of the end post using lag screws or bolts (page 43)
- 130° pivoting allows for easy angled stair terminations
- Typically paired with a Surface Mount Turnbuckle

WOOD/METAL FRAME

SWAGE	ITEM DESCRIPTION	ITEM#	CableØ	EØ	H	W	L
M	1/8" Surface Mount Fixed End	3281	1/8"	1/4"	1-5/16"	5/8"	2-1/8"
M	3/16" Surface Mount Fixed End	3284	3/16"	1/4"	1-5/16"	5/8"	2-1/4"
M	1/4" Surface Mount Fixed End	3337	1/4"	5/16"	1-1/2"	3/4"	3-1/4"
C	Surface Mount Fixed End	3333	1/8"	1/4"	1-5/16"	5/8"	3"
C	3/16" Surface Mount Fixed End	3334	3/16"	1/4"	1-5/16"	5/8"	3"

#3333 same as #3334 but includes insert sleeve for crimping onto 1/8" cable

M MACHINE SWAGED: pre-attached at the factory

C CABLECRIMP™: field swaged

Note on charts: DrillØ is the recommended drill hole size for attaching the fittings to the end posts. Drill hole sizes for all other intermediate posts may differ. Please call to confirm correct drill sizes.

Jaw Fixed End

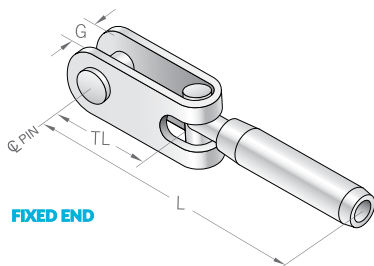

- For metal posts, attaches to inside post face (Level and Stair Railings)
- Attaches quickly to eyebolts, eyelets, or drilled tabs using a removable clevis pin
- 180° pivoting makes these ideal for angled stair terminations
- Typically paired with a Jaw Turnbuckle

METAL FRAME

SWAGE	ITEM DESCRIPTION	ITEM#	CableØ	PinØ	TL	G	L	Pin DrillØ
M	1/8" Jaw Fixed End	3288	1/8"	1/4"	3/4"	5/16"	2-7/8"	5/16"
M	3/16" Jaw Fixed End	3331	3/16"	1/4"	3/4"	5/16"	3"	5/16"
M	1/4" Jaw Fixed End	3336	1/4"	5/16"	1"	3/8"	4-1/8"	3/8"
C	1/8" Jaw Fixed End	3279	1/8"	1/4"	3/4"	5/16"	3-3/4"	5/16"
C	3/16" Jaw Fixed End	3280	3/16"	1/4"	3/4"	5/16"	3-3/4"	5/16"

#3279 same as #3280 but includes insert sleeve for crimping onto 1/8" cable

Button Head Fixed End

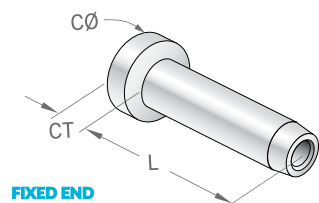

- For metal posts, inserts from outside of end post (Level and Stair railings)
- Single piece fitting with a non-removable, low-profile rounded head
- Fits into a hole drilled through the end post, and the head rests against the outside face of the post
- Use beveled washers (#3791 for 1/8-in and #3793 for 3/16-in) for angled stair terminations and flat washers (page 33) for added bearing surface on wood posts
- Typically paired with another Button Head plus an In-Line Turnbuckle

WOOD/METAL FRAME

SWAGE	ITEM DESCRIPTION	ITEM#	CableØ	CØ	CT	L	DrillØ
M	1/8" Fixed Button End	3287	1/8"	7/16"	1/8"	1"	9/32"
M	3/16" Fixed Button End	3240	3/16"	1/2"	1/8"	1-1/8"	3/8"
C	1/8" Fixed Button End	3290	1/8"	1/2"	1/8"	1-1/4"	9/32"

Lock Toggle Fixed End

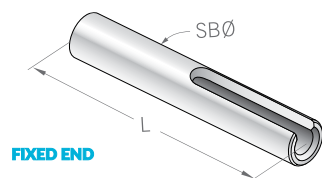

- Used on tubular metal end posts where the design only allows for penetration of one side of the post
- The fitting passes through a drill hole and toggles into a locked position inside the post, leaving no exposed hardware
- Will accommodate angled stair conditions without beveled washers
- Typically paired with another Lock Toggle plus an In-Line Turnbuckle

METAL FRAME

SWAGE	ITEM DESCRIPTION	ITEM#	CableØ	L	SBØ	DrillØ
M	1/8" Fixed Lock Toggle	3169	1/8"	1-1/2"	1/4"	5/16"
C	1/8" Fixed Lock Toggle	3164	1/8"	1-1/2"	7/32"	5/16"

NOTE: Custom fittings are only available SPECIAL ORDER and are bulk packaged.

CABLE·RAIL[®] CUSTOM

Tension Adjustment Fittings

Custom assemblies with a unique look. These fittings are available pre-attached (machine swaged **M**) or ready to attach in the field (CableCrimp[™] **C**) using a CableCrimp[™] tool. For use with Feeney Bulk Cable only. NOTE: Typically paired with a Fixed End Fitting.

Ball End Turnbuckle

- For wood or metal posts
- Inserts through end post
- Screw on ball end
- Level and stair railings
- Pivots for angled terminations
- 1/8", 3/16", or 1/4" cable

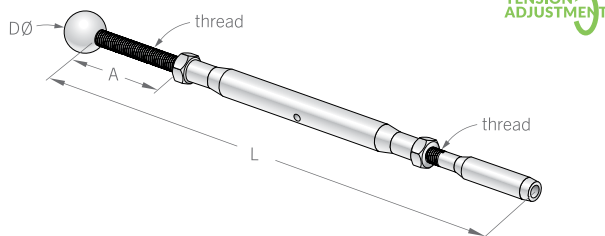

WOOD/METAL FRAME

SWAGE	ITEM DESCRIPTION	ITEM#	CableØ	Thread	DØ	A* CLOSE	L* (CLOSE/OPEN)	DrillØ**
M	1/8" Ball End Turnbuckle	3340	1/8"	1/4-28	5/8"	1-1/4"	7-1/2" (10-1/2")	5/16"
M	3/16" Ball End Turnbuckle	3341	3/16"	1/4-28	5/8"	1-1/4"	8" (11")	5/16"
M	1/4" Ball End Turnbuckle	3342	1/4"	5/16-24	5/8"	2-7/8"	10-1/4" (14")	3/8"
C	1/8" Ball End Turnbuckle	3343	1/8"	1/4-28	5/8"	1-1/4"	8-1/4" (11-1/4")	5/16"
C	3/16" Ball End Turnbuckle	3344	3/16"	1/4-28	5/8"	1-1/4"	8-1/2" (11-1/2")	5/16"

*Longer shaft lengths available **Ball can be slightly recessed into post by counterboring with 9/16" drill.

Cap End Turnbuckle

- For wood or metal posts
- Inserts through end post
- Screw on cap end
- Level and stair railings
- Use beveled washers for stairs
- 1/8", 3/16", or 1/4" cable

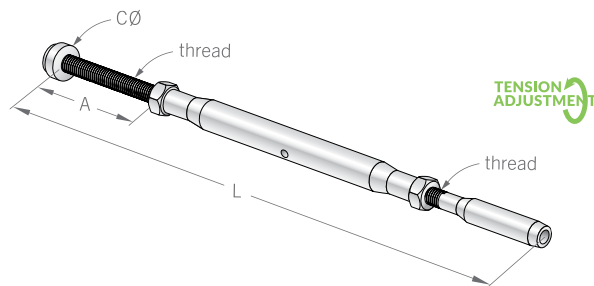

WOOD/METAL FRAME

SWAGE	ITEM DESCRIPTION	ITEM#	CableØ	Thread	CØ	A* CLOSE	L (CLOSE/OPEN)	DrillØ
M	1/8" Cap End Turnbuckle	3325	1/8"	1/4-28	9/16"	1-3/8"	7-3/4" (10-3/4")	5/16"
M	3/16" Cap End Turnbuckle	3326	3/16"	1/4-28	9/16"	1-3/8"	8-1/4" (11-1/4")	5/16"
M	1/4" Cap End Turnbuckle	3327	1/4"	5/16-24	9/16"	3"	10-1/2" (14-1/4")	3/8"
C	1/8" Cap End Turnbuckle	3328	1/8"	1/4-28	9/16"	1-3/8"	8-1/2" (11-1/2")	5/16"
C	3/16" Ball End Turnbuckle	3329	3/16"	1/4-28	9/16"	1-3/8"	8-3/4" (11-3/4")	5/16"

*Longer shaft lengths available

- M** MACHINE SWAGED: pre-attached at the factory
- C** CABLECRIMP[™]: field swaged

Surface Mount Turnbuckle

- For wood or metal posts
- Attaches to inside post face
- Secured with screws or bolts
- Level and stair railings
- 130 degree pivoting
- 1/8", 3/16", or 1/4" cable

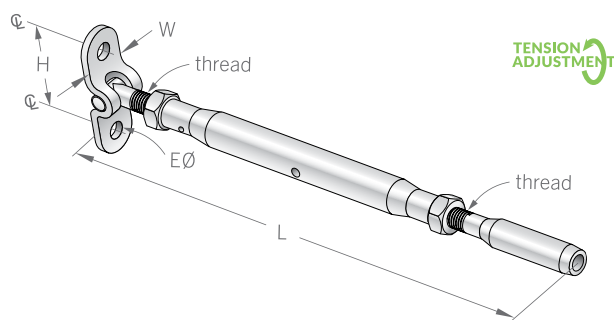

WOOD/METAL FRAME

SWAGE	ITEM DESCRIPTION	ITEM#	CableØ	Thread	EØ	H	W	L (CLOSE/OPEN)
M	1/8" Surface Mount Turnbuckle	3278	1/8"	1/4-28	1/4"	1-5/16"	5/8"	7" (10")
M	3/16" Surface Mount Turnbuckle	3277	3/16"	1/4-28	1/4"	1-5/16"	5/8"	7-1/2" (10-1/2")
M	1/4" Surface Mount Turnbuckle	3338	1/4"	5/16-24	5/16"	1-1/2"	3/4"	8-1/4" (12")
C	1/8" Surface Mount Turnbuckle	3275	1/8"	1/4-28	1/4"	1-5/16"	5/8"	7-3/4" (10-3/4")
C	3/16" Surface Mount Turnbuckle	3276	3/16"	1/4-28	1/4"	1-5/16"	5/8"	8" (11")

Jaw Turnbuckle

- For metal posts
- Attaches to inside post face
- Secured with clevis pin
- Level and stair railings
- 180 degree pivoting
- 1/8", 3/16", or 1/4" cable

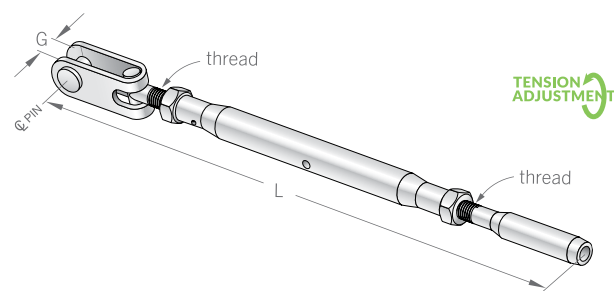

METAL FRAME

SWAGE	ITEM DESCRIPTION	ITEM#	CableØ	Thread	PinØ	G	L (CLOSE/OPEN)	Pin DrillØ
M	1/8" Jaw Turnbuckle	3270	1/8"	1/4-28	1/4"	5/16"	7-3/4" (10-3/4")	5/16"
M	3/16" Jaw Turnbuckle	3271	3/16"	1/4-28	1/4"	5/16"	8-1/4" (11-1/4")	5/16"
M	1/4" Jaw Turnbuckle	3332	1/4"	5/16-24	5/16"	3/8"	9-1/4" (13")	3/8"
C	1/8" Jaw Turnbuckle	3268	1/8"	1/4-28	1/4"	5/16"	8-1/2" (11-1/2")	5/16"
C	3/16" Jaw Turnbuckle	3269	3/16"	1/4-28	1/4"	5/16"	8-3/4" (11-3/4")	5/16"

NOTE: Custom fittings are only available SPECIAL ORDER and are bulk packaged.

CABLE·RAIL[®] CUSTOM

More Tension Adjustment Fittings

Internal Thread Adjuster

- For wood or metal posts
- Inserts through end post
- Level and stair railings
- Use beveled washers for stairs
- 1/8", 3/16", or 1/4" cable

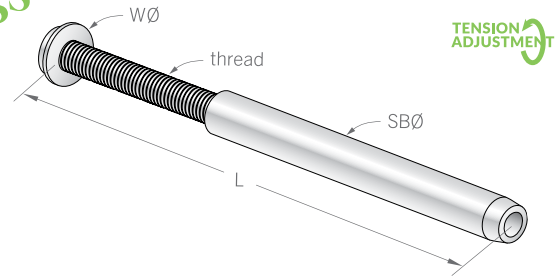

WOOD/METAL FRAME

SWAGE	ITEM DESCRIPTION	ITEM#	CableØ	Thread	WØ	L (CLOSE/OPEN)	SBØ	DrillØ
M	1/8" Internal Thread Adjuster (1-1/2" bolt)	3266-1.5	1/8"	10-24RH	7/16"	2-3/4" (3-3/4")	1/4"	5/16"
M	1/8" Internal Thread Adjuster (2" bolt)	3266-2	1/8"	10-24RH	7/16"	3-1/4" (4-1/4")	1/4"	5/16"
M	1/8" Internal Thread Adjuster (3" bolt)	3266-3	1/8"	10-24RH	7/16"	4-1/4" (5-1/4")	1/4"	5/16"
M	3/16" Internal Thread Adjuster (1-1/2" bolt)	3267-1.5	3/16"	1/4-20RH	11/16"	3-1/4" (4-1/4")	11/32"	3/8"
M	3/16" Internal Thread Adjuster (2" bolt)	3267-2	3/16"	1/4-20RH	11/16"	3-3/4" (4-3/4")	11/32"	3/8"
M	3/16" Internal Thread Adjuster (3" bolt)	3267-3	3/16"	1/4-20RH	11/16"	4-3/4" (5-3/4")	11/32"	3/8"

Inline Turnbuckle

- For any post type
- Use in the middle of the cable assembly
- Level and stair railings
- 1/8", 3/16", or 1/4" cable

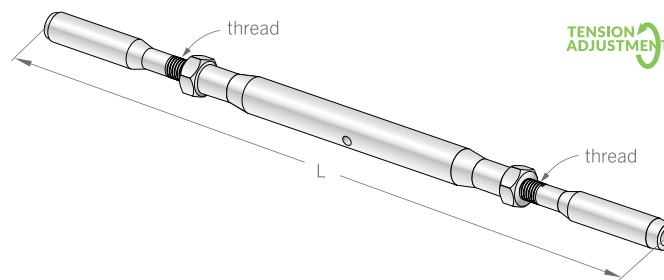

SWAGE	ITEM DESCRIPTION	ITEM#	CableØ	Thread	L (CLOSE/OPEN)
M	1/8" Inline Turnbuckle	3289	1/8"	1/4-28	7-1/2" (10-1/2")
M	3/16" Inline Turnbuckle	3731	3/16"	1/4-28	8-1/2" (11-1/2")
M	1/4" Inline Turnbuckle	3291	1/4"	5/16-24	9-1/2" (13-1/4")
C	1/8" Inline Turnbuckle	3292	1/8"	1/4-28	9" (12")
C	3/16" Inline Turnbuckle	3293	3/16"	1/4-28	9-1/2" (12-1/2")

M MACHINE SWAGED: pre-attached at the factory

C CABLECRIMP™: field swaged

Threaded Terminal

- For wood or metal posts
- Inserts through end post
- Level and stair railings
- Use beveled washers for stairs
- 1/8", 3/16", or 1/4" cable

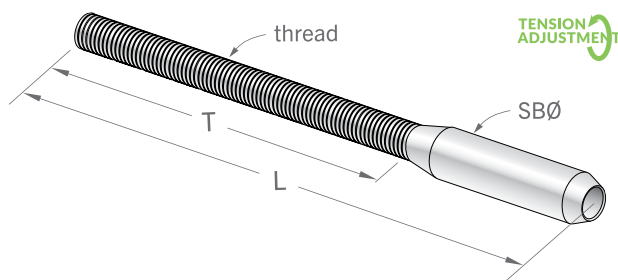

WOOD/METAL FRAME

SWAGE	ITEM DESCRIPTION	ITEM#	CableØ	Thread	T	L	SBØ	DrillØ
M	1/8" Threaded Terminal	3168	1/8"	1/4-20RH	1"	2-1/2"	1/4"	5/16"
M	1/8" Threaded Terminal	3191	1/8"	1/4-20RH	2-1/4"	4-1/4"	1/4"	5/16"
M	1/8" Threaded Terminal	3193	1/8"	1/4-20RH	2-3/4"	7-1/2"	1/4"	5/16"
M	1/8" Threaded Terminal	3197	1/8"	1/4-28RH	2-3/8"	4-1/4"	1/4"	5/16"
M	1/8" Threaded Terminal	3250	1/8"	1/4-28LH	2-1/2"	3-3/4"	1/4"	5/16"
M	3/16" Threaded Terminal	3157	3/16"	1/4-20RH	1"	2-5/8"	11/32"	3/8"
M	3/16" Threaded Terminal	3253	3/16"	1/4-20RH	2-5/8"	4-1/4"	11/32"	3/8"
M	3/16" Threaded Terminal	3256	3/16"	1/4-20RH	2-7/8"	7-1/2"	11/32"	3/8"
M	3/16" Threaded Terminal	3198	3/16"	1/4-28RH	2-1/2"	4-1/4"	11/32"	3/8"
M	3/16" Threaded Terminal	3254	3/16"	1/4-28LH	2-1/2"	4-1/4"	11/32"	3/8"
M	1/4" Threaded Terminal	5050	1/4"	5/16-24RH	2-5/8"	4-3/4"	7/16"	7/16"
M	1/4" Threaded Terminal	3249	1/4"	5/16-24LH	2-3/4"	4-3/4"	7/16"	7/16"
C	1/8" Threaded Terminal	3260	1/8"	1/4-20RH	2-1/4"	4-1/4"	7/32"	5/16"
C	1/8" Threaded Terminal	3251	1/8"	1/4-20RH	2-3/4"	7-1/2"	7/32"	5/16"
C	1/8" Threaded Terminal	3190	1/8"	1/4-28RH	2-1/2"	4-1/2"	7/32"	5/16"
C	1/8" Threaded Terminal	3247	1/8"	1/4-28LH	2-1/2"	4-1/2"	7/32"	5/16"
C	3/16" Threaded Terminal	3263	3/16"	1/4-20RH	2-5/8"	4-7/8"	9/32"	3/8"
C	3/16" Threaded Terminal	3264	3/16"	1/4-20RH	5-1/2"	7-7/8"	9/32"	3/8"
C	3/16" Threaded Terminal	3192	3/16"	1/4-28RH	2-1/2"	4-3/4"	9/32"	3/8"
C	3/16" Threaded Terminal	3248	3/16"	1/4-28LH	2-1/2"	4-3/4"	9/32"	3/8"

NOTE: Custom fittings are only available SPECIAL ORDER and are bulk packaged.

CABLE·RAIL[®] CUSTOM

Sleekline Turnbuckles

Sleekline turnbuckles have a swage sleeve hidden inside the body with clean lines and no exposed threads or swage ends. These fittings are available pre-attached (machine swaged **M**) or ready to attach in the field (CableCrimp™ **C**) using a CableCrimp™ Crimper tool. For use with Feeney Bulk Cable only.

Sleekline Hidden Swage Sleeve

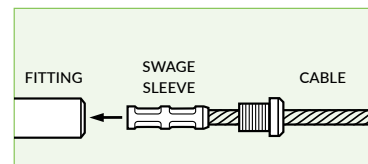

Sleekline Ball End Turnbuckle

- For wood or metal posts
- Inserts through end post
- Screw on ball end
- Level and stair railings
- Pivots for angled terminations

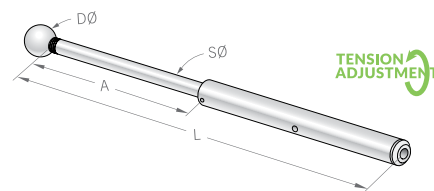

WOOD/METAL FRAME

SWAGE	ITEM DESCRIPTION	ITEM#	CableØ	Thread	DØ	A CLOSE	L (CLOSE/OPEN)	DrillØ**
M	1/8" Sleekline Ball End Turnbuckle	3350	1/8"	5/8"	3-3/8"	1/4"	8-1/8" (9-3/4")	5/16"
M	3/16" Sleekline Ball End Turnbuckle	3345	3/16"	5/8"	3-3/8"	1/4"	8-1/8" (9-3/4")	5/16"
C	1/8" Sleekline Ball End Turnbuckle	3351	1/8"	5/8"	3-3/8"	1/4"	8-1/8" (9-3/4")	5/16"
C	3/16" Sleekline Ball End Turnbuckle	3346	3/16"	5/8"	3-3/8"	1/4"	8-1/8" (9-3/4")	5/16"

**Ball can be slightly recessed into post by counterboring with 9/16" drill.

Sleekline Cap End Turnbuckle

- For wood or metal posts
- Inserts through end post
- Screw on cap end
- Level and stair railings
- Use beveled washers for stairs

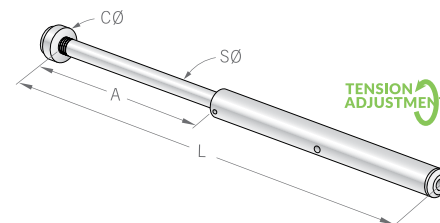

WOOD/METAL FRAME

SWAGE	ITEM DESCRIPTION	ITEM#	CableØ	CØ	A CLOSE	SØ	L (CLOSE/OPEN)	DrillØ
M	1/8" Sleekline Cap End Turnbuckle	3282	1/8"	9/16"	3-1/2"	1/4"	8-1/4" (9-7/8")	5/16"
M	3/16" Sleekline Cap End Turnbuckle	3300	3/16"	9/16"	3-1/2"	1/4"	8-1/4" (9-7/8")	5/16"
C	1/8" Sleekline Cap End Turnbuckle	3302	1/8"	9/16"	3-1/2"	1/4"	8-1/4" (9-7/8")	5/16"
C	3/16" Sleekline Cap End Turnbuckle	3305	3/16"	9/16"	3-1/2"	1/4"	8-1/4" (9-7/8")	5/16"

Sleekline Jaw Turnbuckle

- For metal posts
- Attaches to inside post face
- Secured with clevis pin
- Level and stair railings
- 180 degree pivoting

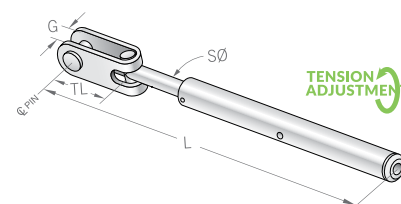

METAL FRAME

SWAGE	ITEM DESCRIPTION	ITEM#	CableØ	Pin DrillØ**	TL	G	SØ	L (CLOSE/OPEN)	Pin DrillØ
M	1/8" Sleekline Jaw Turnbuckle	3295	1/8"	1/4"	3/4"	5/16"	1/4"	6-3/8" (8")	5/16"
M	3/16" Sleekline Jaw Turnbuckle	3296	3/16"	1/4"	3/4"	5/16"	1/4"	6-3/8" (8")	5/16"
C	1/8" Sleekline Jaw Turnbuckle	3297	1/8"	1/4"	3/4"	5/16"	1/4"	6-3/8" (8")	5/16"
C	3/16" Sleekline Jaw Turnbuckle	3299	3/16"	1/4"	3/4"	5/16"	1/4"	6-3/8" (8")	5/16"

M MACHINE SWAGED: pre-attached at the factory

C CABLECRIMP™: field swaged

Sleekline Surface Mount Turnbuckle

- For wood or metal posts
- Attaches to inside post face
- Secured with screws or bolts
- Level and stair railings
- 130 degree pivoting

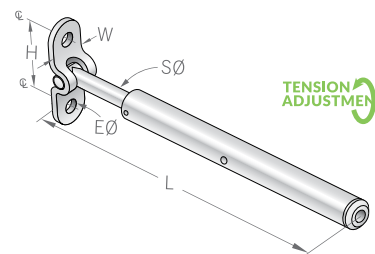

WOOD/METAL FRAME

SWAGE	ITEM DESCRIPTION	ITEM#	CableØ	EØ	H	W	SØ	L (CLOSE/OPEN)
M	1/8" Sleekline Surface Mount Turnbuckle	3309	1/8"	1/4"	1-5/16"	5/8"	1/4"	5-5/8" (7-1/4")
M	3/16" Sleekline Surface Mount Turnbuckle	3310	3/16"	1/4"	1-5/16"	5/8"	1/4"	5-5/8" (7-1/4")
C	1/8" Sleekline Surface Mount Turnbuckle	3311	1/8"	1/4"	1-5/16"	5/8"	1/4"	5-5/8" (7-1/4")
C	3/16" Sleekline Surface Mount Turnbuckle	3312	3/16"	1/4"	1-5/16"	5/8"	1/4"	5-5/8" (7-1/4")

Bulk Cable (REQUIRED)

Cables used in railings and architectural applications are uncoated 1x19 and 7x7 cables of type-316 stainless steel. Cables are constructed for high abrasion resistance and low maintenance, available in 1/8-in, 3/16-in, and 1/4-in.

ITEM#	CABLE Ø	CONSTRUCTION
4140	1/8"	1x19
4126	1/8"	7x7
4117	3/16"	1x19
4129	3/16"	7x7
4118	1/4"	1x19
4200	1/4"	7x7

1x19 Construction Cables

- 19 individual wires twisted into a single, semi-flexible strand
- Excellent for railings, fences, and trellises with straight runs or slight bends

1x19



7x7 Construction Cables

- 49 individual wires woven into a flexible strand
- Best for conditions that require tighter bends or for designs where a more woven wire appearance is desired

7x7



Also available: clear and colored vinyl and nylon coated cables and a wide assortment of other stainless, galvanized, and bright steel cables and wire ropes. For details, contact a Feeney Estimator.

CableCrimp™ Crimper Tool

For attaching cables to CableCrimp™ swaged fittings - see included instructions for correct usage.

SPECIAL ORDER ITEM DESCRIPTION	ITEM#
Crimper Tool	3742



NOTE: Custom fittings are only available SPECIAL ORDER and are bulk packaged.

Additional Components & Tools

Complete your railing with pickets, end caps, and more. Feeney engineered tools make installation easy!

Intermediate Pickets

Feeney Intermediate Pickets are REQUIRED to prevent cable deflection when structural posts are placed more than 3' apart. Pickets can be used with any CableRail solution.

Pickets are available in square powder-coated aluminum; 3 standard colors or one of our 15 ColorEasy™ colors via special order. Stainless steel tubular pickets are also an option. Each picket includes all attachment hardware.

Powder-Coated Aluminum Pickets (SQUARE, ANY FRAMES)



LEVEL, WHITE

STAIR, WHITE

LEVEL, SILVER

STAIR, SILVER

LEVEL, BLACK

STAIR, BLACK

WOOD/METAL FRAME

RETAIL ITEM DESCRIPTION	ITEM# [QTY]	CASE ITEM# [QTY]
POWDER-COATED ALUMINUM INTERMEDIATE PICKETS - SQUARE		
Silver Aluminum Intermediate Picket (Level)	CRPK : 7648 SLV-PKG [1/pack]	CRPK : 7648 SLV-CS [10 packs]
Silver Aluminum Intermediate Picket (Stair)	CRPK : 7649 SLV-PKG [1/pack]	CRPK : 7649 SLV-CS [10 packs]
Black Aluminum Intermediate Picket (Level)	CRPK : 7648 BLK-PKG [1/pack]	CRPK : 7648 BLK-CS [10 packs]
Black Aluminum Intermediate Picket (Stair)	CRPK : 7649 BLK-PKG [1/pack]	CRPK : 7649 BLK-CS [10 packs]
White Aluminum Intermediate Picket (Level)	CRPK : 7648 WHT-PKG [1/pack]	CRPK : 7648 WHT-CS [10 packs]
White Aluminum Intermediate Picket (Stair)	CRPK : 7649 WHT-PKG [1/pack]	CRPK : 7649 WHT-CS [10 packs]

WOOD FRAME

RETAIL ITEM DESCRIPTION	ITEM# [QTY]	CASE ITEM# [QTY]
STAINLESS STEEL INTERMEDIATE PICKETS - TUBULAR		
SS Intermediate Picket for 36" Level Wood Frame	SSPK : 36L-PKG [1/pack]	SSPK : 36L-CS [10 packs]
SS Intermediate Picket for 42" Level Wood Frame	SSPK : 42L-PKG [1/pack]	SSPK : 42L-CS [10 packs]
SS Intermediate Picket for Stair Wood Frame	SSPK : STR-PKG [1/pack]	SSPK : STR-CS [5 packs]

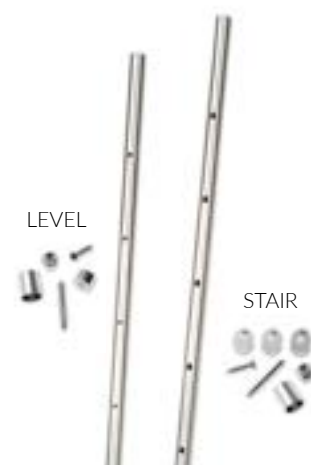

Stainless Steel Pickets
(TUBULAR - WOOD FRAMES ONLY)

End Caps (STANDARD KITS & ATR KITS)

For use as a finish element to cover fittings and attachment hardware. Available in durable polyethylene (9 colors) or stainless steel (3 styles) for CableRail Standard Kits or All-Thread Receiver Kits.

STAINLESS STEEL

RETAIL ITEM DESCRIPTION	ITEM# [QTY]	CASE ITEM# [QTY]	BULK #
Stainless Steel End Caps, Dome	SSEC : 3372-PKG [4/pack]	3372-CS [24 packs]	3372
Stainless Steel End Caps, Crown	SSEC : 3373-PKG [4/pack]	3373-CS [24 packs]	3373
Stainless Steel End Caps, Chamfer	SSEC : 3374-PKG [4/pack]	3374-CS [24 packs]	3374



Black

POLYETHYLENE

RETAIL ITEM DESCRIPTION	ITEM# [QTY]	CASE ITEM# [QTY]	BULK #
Colored End Caps, Black	CEC : 7071-PKG [10/pack]	7071-CS [24 packs]	7071
Colored End Caps, White	CEC : 7072-PKG [10/pack]	7072-CS [24 packs]	7072
Colored End Caps, Brown	CEC : 7073-PKG [10/pack]	7073-CS [24 packs]	7073
Colored End Caps, Gray	CEC : 7074-PKG [10/pack]	7074-CS [24 packs]	7074
Colored End Caps, Bronze	CEC : 7077-PKG [10/pack]	7077-CS [24 packs]	7077



SPECIAL ORDER ITEM DESCRIPTION	ITEM#
Colored End Caps, Silver	CEC : 7075
Colored End Caps, Taupe	CEC : 7076
Colored End Caps, Green	CEC : 7078
Colored End Caps, Cream	CEC : 7079

NOTE: SPECIAL ORDER ITEMS are bulk packaged.

CABLE·RAIL®

Conceal Kit Tools

The tools required for Conceal Kit installation are included in one kit, for your convenience.

SPECIAL ORDER ITEM DESCRIPTION	ITEM#
Conceal Tool Kit (Includes a Conceal Star Driver, a combo ratcheting box wrench, and a 5/32" T-Handle Hex Wrench.	CRC-KIT
Conceal Star Driver Tool	CSDT
Conceal Cap Removal Tool	CCRT



5/32" T-HANDLE HEX WRENCH
Inserts into Conceal Terminal through the Star Driver.



STAR DRIVER TOOL
Attaches to 9/16" Hex Wrench and inserts into Conceal Terminal.



RATCHETING BOX WRENCH



CONCEAL CAP REMOVAL TOOL
Easy-to-use tool for removing Conceal End Caps.

Conceal Kit End Caps

For use with Conceal Kits as a finish element to cover Conceal fittings. Conceal End Caps are available in 4 powder-coated colors or stainless steel.



Post shown with cap white cap.



WOOD/DESIGNRAIL® CUSTOM

SPECIAL ORDER ITEM DESCRIPTION	ITEM# [QTY]
Conceal End Cap, Black	CCP : Black
Conceal End Cap, Bronze	CCP : Bronze
Conceal End Cap, Silver	CCP : Silver
Conceal End Cap, White	CCP : White
Conceal End Cap, Stainless Steel	CCP
Conceal End Cap, Gray Plastic	CCP : PL Gray

Conceal Washers

Flat washers for wood frames, beveled washer for stair applications, and isolation bushings for termination posts.

WOOD/DESIGNRAIL® CUSTOM

SPECIAL ORDER ITEM DESCRIPTION	ITEM# [QTY]
32° Conceal Beveled Washer (3/8" ID x 5/8" OD)	CBW
CableRail Conceal Flat Washer for Wood - Stainless Steel	CWW
Isolation Bushing for Termination Posts (outside face)	1114



CBW

Conceal Kit Decorative Bushings

Special stainless steel decorative bushings provide a finish element to post holes for either wood or DesignRail® frames.

WOOD/DESIGNRAIL® CUSTOM

SPECIAL ORDER ITEM DESCRIPTION	ITEM#
Conceal Decorative Bushing for Wood - LEVEL (short)	CWDB
Conceal Decorative Bushing for Wood - STAIR (long)	CWHR
Conceal Decorative Bushing for DesignRail® - LEVEL (Stainless Steel)	CHR
Conceal Decorative Bushing for DesignRail® - LEVEL (Black)	CHR Black
Conceal Decorative Bushing for DesignRail® - LEVEL (Bronze)	CHR Bronze
Conceal Decorative Bushing for DesignRail® - LEVEL (Silver)	CHR Silver
Conceal Decorative Bushing for DesignRail® - LEVEL (White)	CHR White

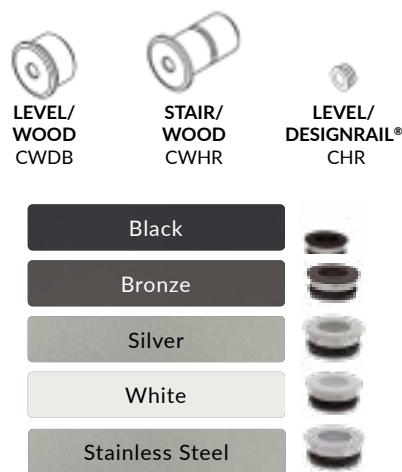

Isolation Bushings (CONCEAL KITS & STANDARD KITS)

Isolation bushings are required in harsh environment conditions for Conceal in DesignRail® frames.

DESIGNRAIL® CUSTOM

SPECIAL ORDER ITEM DESCRIPTION	ITEM#
Conceal Isolation Bushing, DesignRail® Level Conceal End Post, <i>outside</i> (CE)	1114
Conceal Isolation Bushing, DesignRail® Conceal End Post, <i>inside</i> (CE)	1109
Conceal Isolation Bushing, DesignRail® Conceal End Stair Post, <i>outside</i> (CES)	CBS
Conceal Isolation Bushing, DesignRail® Conceal End Stair Post, <i>inside</i> (CES)	1120
Isolation Bushing, DesignRail® Level Intermediate Post (IN)	1107
Isolation Bushing, DesignRail® Level Intermediate Picket (PK)	1108
Isolation Bushing, DesignRail® Level Single Corner & Stair Int. Post (SC/INS)	1121
Isolation Bushing, DesignRail® Stair Intermediate Picket (INS)	1122

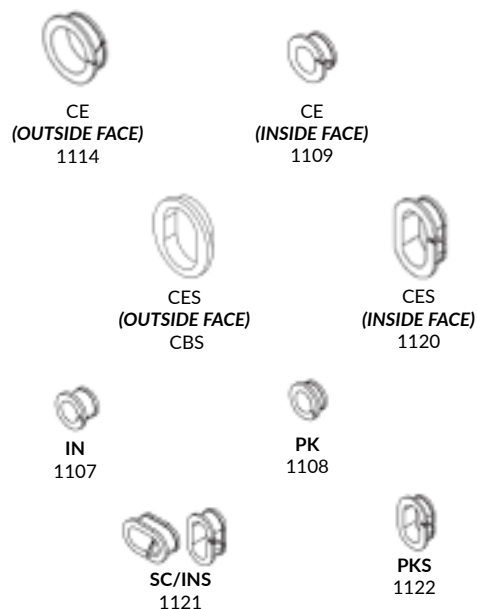

NOTE: SPECIAL ORDER ITEMS are bulk packaged.

Beveled Washers (STANDARD KITS & ATR KITS)

FOR 1/8" STANDARD KITS (32°)

Stainless steel angled washers are used in stair applications, for fittings that pass through the post and anchor to the outside post face. Note: 3799 and 3792 are typically used for 1/8" Standard CableRail Kits (at common 32 degree stair angle); all others are for use with 3/16" & 1/4" Kits or custom fittings or other angle ranges.



RETAIL ITEM DESCRIPTION	ITEM# [QTY]	CASE ITEM# [QTY]	BULK #
32° SS Beveled Washer for 1/8" TT (9/32" ID x 3/4" OD)	3799-PKG [4/pack]	3799-CS [24 packs]	3799
32° SS Beveled Washer for 1/8" QC (3/8" ID x 3/4" OD)	3792-PKG [4 pack]	3792-CS [24 packs]	3792

SPECIAL ORDER ITEM DESCRIPTION	INNER Ø	OUTER Ø	ANGLE	ITEM# [QTY]
26° SS Beveled Washer for 1/8" QC & 1/4" TT	3/8"	3/4"	26°	3794
26° SS Beveled Washer for 3/16" QC & 1/4" TT	3/4"	3/4"	26°	3795
26° SS Beveled Washer for 1/8" TT & 3/16" TT	9/32"	3/4"	26°	3790
32° SS Beveled Washer for 1/4" TT w/ Acorn Nut	3/8"	5/8"	32°	3793
32° SS Beveled Washer	1/4"	1/2"	32°	3791
32° SS Beveled Washer for 3/16" QC & 1/4" TT	1/4"	3/4"	32°	3798
37° SS Beveled Washer for 1/8" QC & 1/4" TT	3/8"	3/4"	37°	3797
37° SS Beveled Washer for 3/16" QC & 1/4" TT	9/16"	3/4"	37°	3796

Protector Sleeves

Stainless steel sleeves protect holes in wood or composite posts from cable abrasion. They are typically used in corner and stair transition posts, but can also be used in intermediate posts. For stair applications, pair with Protector Sleeve Beveled washers.

WOOD FRAME ONLY

RETAIL ITEM DESCRIPTION	ITEM# [QTY]	CASE ITEM# [QTY]	BULK #
Stainless Steel Protector Sleeves	3210-PKG [10/pack]	3210-CS [24 packs]	3210



3210-PKG

SPECIAL ORDER ITEM DESCRIPTION	ITEM# [QTY]
Protector Sleeve Beveled Washer (STAIRS)	BW : PBW



BW : PBW

CableRail Hardware



SNUG-GRIP® WASHER NUT ▶

To attach Threaded Terminals to posts



HEX NUT ▶

To attach Threaded Terminals to posts; typically paired with Cap Nut.



CAP NUT ▶

For finishing and locking Hex Nuts.



NYLON INSERT LOCK NUT ▶

To attach Threaded Terminals to posts; typically paired with Retaining Washer, covered with End Cap.



RETAINING WASHER ▶

For attaching Colored End Caps over Hex Nuts and Nylon Insert Lock Nuts.

SPECIAL ORDER ITEM DESCRIPTION	ITEM#
Flat Washer, SS, 1/4" ID x 11/16" OD	3180
Flat Washer, SS, 1/4" ID x 1" OD	3181
Flat Washer, SS, 5/16" ID x 3/4" OD	3231
Flat Washer, SS, 3/8" ID x 1" OD	3378
Flat Washer, SS, 9/16" ID x 1" OD	3177
Flat Washer, Nylon, 1/4" ID x 7/16" OD, White	3381
Flat Washer, Nylon, 1/4" ID x 3/4" OD, White	3375
Flat Washer, Nylon, 5/16" ID x 3/4" OD, White	3377
Flat Washer, Nylon, 3/8" ID x 3/4" OD, White	3376
Flat Washer, Nylon, 9/16" ID x 3/4" OD, White	3379
Flat Washer, Nylon, 1/4" ID x 3/4" OD, Black	3375-Blk
Flat Washer, Nylon, 5/16" ID x 3/4" OD, Black	3377-Blk
Flat Washer, Nylon, 3/8" ID x 3/4" OD, Black	3376-Blk
Flat Washer, Nylon, 9/16" ID x 3/4" OD, Black	3379-Blk



◀ FLAT WASHER (SS)

For providing additional bearing surface to end fittings on wood posts.



◀ FLAT WASHER (NYLON)

For protecting metal posts from nut abrasion and electrolysis

SPECIAL ORDER ITEM DESCRIPTION	ITEM#
Snug-Grip® Washer Nut, SS, 1/4-20RH	3370
Snug-Grip® Washer Nut, SS, 5/16-24RH	3371
Nylon Insert Locknut, SS, 1/4-20RH	3121
Nylon Insert Locknut, SS, 1/4-28RH	3175
Hex Nut, SS, 1/4-20RH	3143
Hex Nut, SS, 1/4-28RH	3178
Hex Nut, SS, 1/4-28LH	3243
Hex Nut, SS 5/16-24RH	3244
Hex Nut, SS, 5/16-24LH	3242
Cap Nut, SS, 1/4-20RH	3144
Cap Nut, SS, 1/4-28RH	3179
Cap Nut, SS, 5/16-24RH	3188
Retaining Washer, SS, 1/4" x 5/8"OD	7070

SPECIAL ORDER ITEM DESCRIPTION	ITEM#
Isolation Bushing 3/8" ID x 15/32" OD x 11/16" flange	ISO : 1100
Isolation Bushing 3/16" ID x 1/4" OD x 3/8" flange	ISO : 1101
Isolation Bushing 1/4" ID x 5/16"OD x 1/2" flange	ISO : 1102
Isolation Bushing 35/64" ID x 5/8" OD x 55/64" flange	ISO : 1103
Isolation Bushing 9/32" ID x 23/64" OD x 19/32" flange	ISO : 1104
Isolation Bushing 7/16" ID x 17/32" OD x 3/4" flange	ISO : 1105
Isolation Bushing 5/16" ID x 3/8" OD x 9/16" flange	ISO : 1115
Isolation Bushing 15/32" ID x 35/64" OD x 25/32" flange	ISO : 1118
Isolation Bushing 13/64" ID x 15/64" OD x 7/32" FL, single flange	ISO : 1123
Isolation Bushing 25/64" ID x 7/16" OD x 3/8" FL, single flange	ISO : 1124

▲ ISOLATION BUSHINGS

For eliminating direct contact of dissimilar metals to minimize electrolysis when attaching cables and fittings to metal posts in areas with salt air or similar harsh elements.

Made from engineered polymer, bushings are highly resistant to abrasion and UV degradation with a wide operating temperature range, -40°F to +266°F. Must use silicone sealant (not included) to secure bushings in posts.



HEX HEAD BOLT ▼

For attaching Surface Mount Fittings to metal posts.



HEX HEAD LAG SCREW ▼

For attaching Surface Mount Fittings to wood posts.



BUTTON HEAD LAG SCREW ▼

For attaching Surface Mount Fittings to wood posts; requires S2 square-drive bit.



SHOULDER EYEBOLT ▼

For attaching Jaw Fittings to posts; includes washer and hex nut.

SPECIAL ORDER ITEM DESCRIPTION	ITEM#
Lag Screw, Hex Head, SS, 1/4" X 2"	3183
Lag Screw, Button Head, SS, 1/4" X 2", Square Drive	7918
Hex Head Bolt, SS, 1/4-20 X 3/4"	3322

NOTE: SPECIAL ORDER ITEMS are bulk packaged.

Maintenance

Stainless Steel Cleaner Kit



Clean and maintain all stainless steel surfaces, fittings, and cables. Kit includes: (1) bottle of SteelRenewal™, (1) bottle of SteelProtect™, applicator brush and sponge, protective gloves. Available bundled with the CableRail Multi-Tool (see facing page for details).

RETAIL ITEM DESCRIPTION	ITEM# [QTY]	CASE ITEM# [QTY]
Stainless Steel Cleaner & Protectant Kit	SRSP : SRSP : 5064-PKG [1/pack]	SRSP : SRSP : 5064-CS [6 packs]
SPECIAL ORDER ITEM DESCRIPTION	ITEM#	
CableRail Kit for 1/8" cable (includes Multi-Tool)	vCR-Kit	
CableRail Kit for 3/16" cable (includes Multi-Tool)	CRK : CR-Kit-3-16	

Tools

Cable Lacing Needles

For quickly lacing cable ends through posts without snagging.



CABLE LACING NEEDLE



CURVED LACING NEEDLE

Curved needle for use with DesignRail® Single Corner Post.

RETAIL ITEM DESCRIPTION	ITEM# [QTY]	CASE ITEM# [QTY]	BULK #
1/8" Cable Lacing Needle	3221-PKG [1/pack]	3221-CS [12 packs]	3221
1/8" Curved Lacing Needle	322-CURVE-PKG [1/pack]	3221-CURVE-CS [12 packs]	3221-CURVE
SPECIAL ORDER ITEM DESCRIPTION	ITEM# [QTY]		
3/16" Cable Lacing Needle	3222		
1/4" Cable Lacing Needle	3223		

Hanger Bolt Installation Tool (LAG/PIVOT FITTINGS)



For easy installation of the hanger bolts for use with with Quick-Connect® Lag and Pivot fittings. Inserts easily into minimum 1/2" drill chuck for quick installation.

RETAIL ITEM DESCRIPTION	ITEM# [QTY]	CASE ITEM# [QTY]
Hanger Bolt Installation Tool - 1/8"	3988-PKG [1/pack]	3988-CS [20 packs]
SPECIAL ORDER ITEM DESCRIPTION	ITEM#	
Hanger Bolt Installation Tool - 3/16"	3989	

Quick-Connect® Release Tool

For releasing the Quick-Connect® jaws to remove or adjust fitting.



RETAIL ITEM DESCRIPTION	ITEM# [QTY]	CASE ITEM# [QTY]	BULK #
QC Release Tool (1/8")	3128-PKG [1/pack]	3128-CS [24 packs]	3128
QC Release Tool (3/16")			3158

CableRail Cable Cutters



For shearing stainless steel cables, 1x19 construction.

RETAIL ITEM DESCRIPTION	ITEM# [QTY]	CASE ITEM# [QTY]	BULK #
Cable Cutters (up to 1/8")	2972-PKG [1/pack]	2972-CS [6 packs]	2972
SPECIAL ORDER ITEM DESCRIPTION	ITEM#		
Cable Cutters (up to 1/4")	2971		

Professional Cable Tension Gauge



Easy-to-use tool for checking cable tension.

RETAIL ITEM DESCRIPT.	ITEM# [QTY]	CASE ITEM# [QTY]
Cable Tension Gauge	TG-PKG [1/pack]	TG-CS [10 packs]

Tensioning Tool (STANDARD KITS & ATR KITS)



This handy tool makes Standard/ATR CableRail Kit installation so much faster! Includes 90-Degree adapter and guide plates for 1/8" and 3/16" cable.

RETAIL ITEM DESCRIPT.	ITEM# [QTY]
Cable Tensioning Tool Kit for 1/8" & 3/16" cable	TNT: KIT90-PKG [1/pack]

90-DEGREE ADAPTER

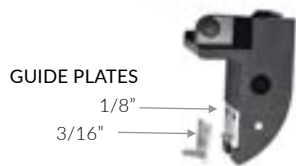

Upgrades for your older Tensioning Tool and replacement parts are available:

SPECIAL ORDER ITEM DESCRIPTION	ITEM#
90-Degree Adapter for Cable Tensioning Tool	TNT: 90-PKG
Guide Plate for 1/8" cable	TNT : TNT : GP-0.125
Guide Plate for 3/16" cable	TNT : TNT : GP-0.188

Wrench Wheel (QUICK-CONNECT® FITTINGS)



An easy-to-use tool for tensioning Quick-Connect® Tensioner fittings that allows for continuous full rotation without requiring repositioning of wrenches.

RETAIL ITEM DESCRIPTION	ITEM# [QTY]	CASE ITEM# [QTY]
Wrench Wheel	6006-PKG [1/pack]	6006-CS [10 packs]

CableRail Multi-Tool



Five great CableRail tools in one! Includes taper, stainless steel ruler/depth gauge, bubble level, Quick-Connect® Release Tool, and Cable Lacing Needle.

RETAIL ITEM DESCRIPTION	ITEM#
CableRail Multi-Tool	MT-1/8

NOTE: SPECIAL ORDER ITEMS are bulk packaged.