

Feeney Intermediate Pickets are non-structural railing members designed to help maintain CableRail spacing and minimize cable deflection. The #7648 kits are for level wood railing frames (with or without bottom rails) up to 42" high and having 1/8" CableRail infill cables spaced 3" on center. Before beginning installation, the entire railing frame must be constructed and posts drilled for the CableRail infill. We recommend that you have a vertical member, either post or intermediate picket, spaced no further than 3-ft on center. Consult local building code for all railing construction requirements in your area.

**Kit Contents:** (1x) 44" Intermediate Picket with 13 cable holes spaced 3" on center, (2x) Base Plates, (6x) #10x1" stainless steel #2 Square Drive Screws

**Tools Required:** safety glasses, hearing protection, work gloves, measuring tape, pencil, miter saw with fine-toothed carbide-tipped blade, electric drill/driver, #2 square drive bit, 1/8" drill bit, level

### STEP 1 - Measure Opening

- Measure the distance between top and bottom rail or top rail and deck surface.
- Subtract 3/8" from your measurement to account for the base plates, this will be your picket cut length.

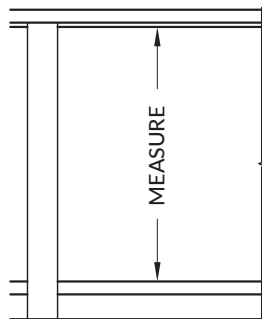

(with bottom rail)

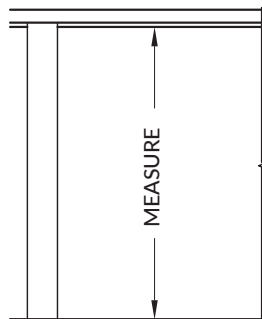

(without bottom rail)

### STEP 2 - Mark & Trim Picket

- Transfer the cut length from Step 1 onto the corresponding picket and mark the cut locations.
- Trim the picket at the cut marks using a miter saw with a fine-toothed carbide-tipped blade.

*Important Note: double check your cut marks to be sure that once the picket is cut and base plates attached, the cable drill holes will align with the drill holes on your post.*

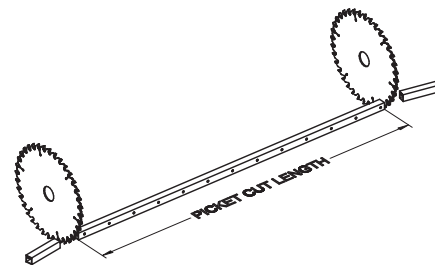



# Installation Instructions

Feeney Intermediate Picket (SKU#7648) - For Level Railings Only

## STEP 3 - Attach Base Plates

- Screw the Base Plates to both ends of the picket using an electric drill with a #2 square drive bit.

*Important Note: To prevent screw head damage and ease installation, lubricate the screw threads with wax or soap prior to attachment and drive the screws slowly and smoothly with minimal stopping and starting. In addition, be sure to firmly secure the picket so that it won't move during attachment of the base plates.*

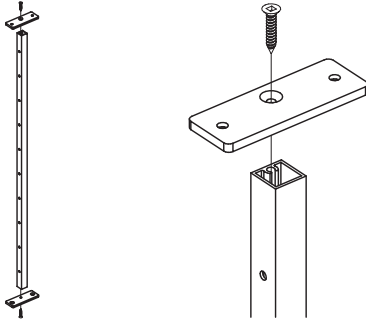

## STEP 4 - Attach Picket to Railing

- Slide the picket into position and verify that it is plumb.
- Confirm that all picket cable holes are properly aligned with holes in the posts.
- Drill 1/8" diameter pilot holes for the screws (softer woods may need a smaller pilot drill).
- Secure the picket into position with screws.

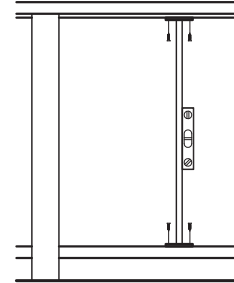

(with bottom rail)

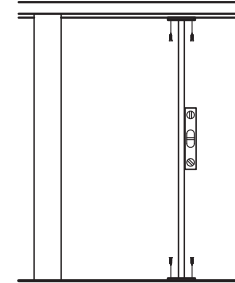

(without bottom rail)

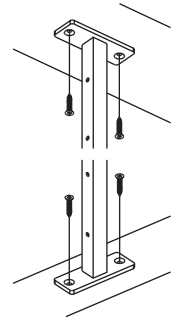

Once all pickets have been installed, the railing frame will be ready for installing the cables. Follow the CableRail by Feeney installation instructions to complete the railing infill installation. If you have questions, please call us at 1-800-888-2418.