

SECTION
SCALE: 1:1

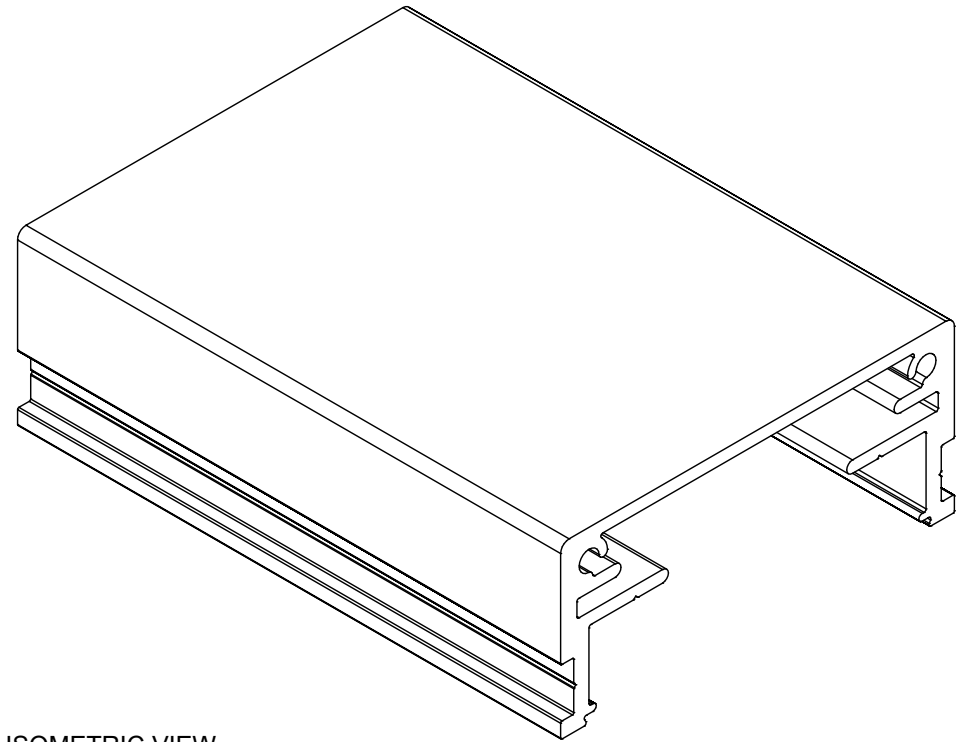

ISOMETRIC VIEW
SCALE: NTS

DesignRail® Extrusion Pattern:
SERIES 450 TOP RAIL

THIS DRAWING IS THE PROPERTY OF FEENEY INC. ANY REPRODUCTION OF THIS DOCUMENT WITHOUT THE EXPRESSED WRITTEN CONSENT OF FEENEY INC. IS STRICTLY PROHIBITED.

MATERIAL:	6005-T5 ALUMINUM ALLOY	DATE:	01/03/17
SKU (10' / 20'):	7749 / 7748	PAGE:	1 of 1
		REV:	
		BY:	DSY
		CHK:	BWA



2603 Union St., Oakland, CA 94607
P: 800-888-2418 F: 510-893-9484
www.feeneyinc.com